



Spectra Precision Laser GL412N/GL422N



User Guide

Contractors-Tools.com
Call 1-877-866-5721

TABLE OF CONTENTS

Introduction

For Your Safety

Components

How to Use the Laser System

Powering the Laser

Turning On/Off the Laser

Turning On/Off the Radio Remote Control

Pairing the remote control and the HL760 receiver with the transmitter

Laser Setup

Standard Features

Manual Mode

Mask mode

Activating/Deactivating Standby Mode

Line Scan - Vertical Setup

MENU Features

Y-X-Grade Entering

Selecting Rotation Speed

Automatic Grade Match

Automatic PlaneLok mode

Mask Mode

Temperature Check

Setting Menu

Info

Service menu

Line Scan (Vertical Setup)

Setting menu details

HI-alert selection

Grade Entry

Grade Display

Sensitivity

Language

Radio Channel

CALIBRATION

Checking Calibration of the Y- and X-Axes

Checking Calibration of the Z-(vertical) Axis

PROTECTING THE UNIT

CLEANING AND MAINTENANCE

PROTECTING THE ENVIRONMENT

WARRANTY

TECHNICAL DATA

Introduction

Thank you for choosing one of the Spectra Precision Lasers from the Trimble family of precision lasers. The grade laser is an easy-to-use tool that offers accurate horizontal, vertical and sloped laser reference up to 1300 ft (400 m) away using a receiver.

For Your Safety

For hazardless and safe operation, read all the user guide instructions.



- Use of this product by people other than those trained on this product may result in exposure to hazardous laser light.
- Do not remove warning labels from the unit.
- The GL422N/GL412N is a class 2 laser (<3,4mW) IEC 60825-1:2014)
- **Never** look into the laser beam or direct it to the eyes of other people.
- Always operate the unit in a way that prevents the beam from getting into people's eyes.
- If initial service is required, which results in the removal of the outer protective cover, removal must only be performed by factory-trained personnel.

Caution: Use of other than the described user and calibration tools or other procedures may result in exposure to hazardous laser light.



Caution: Using different than described at the GL422N/GL412N user guide, may result in unsafe operation.

GL4X2N - Components

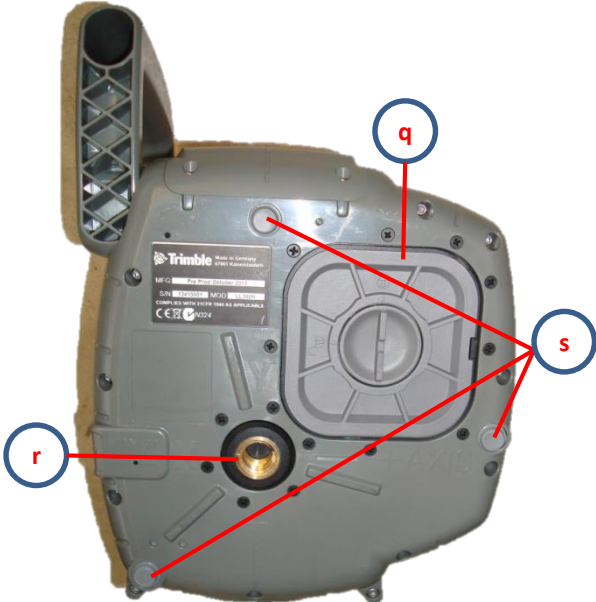
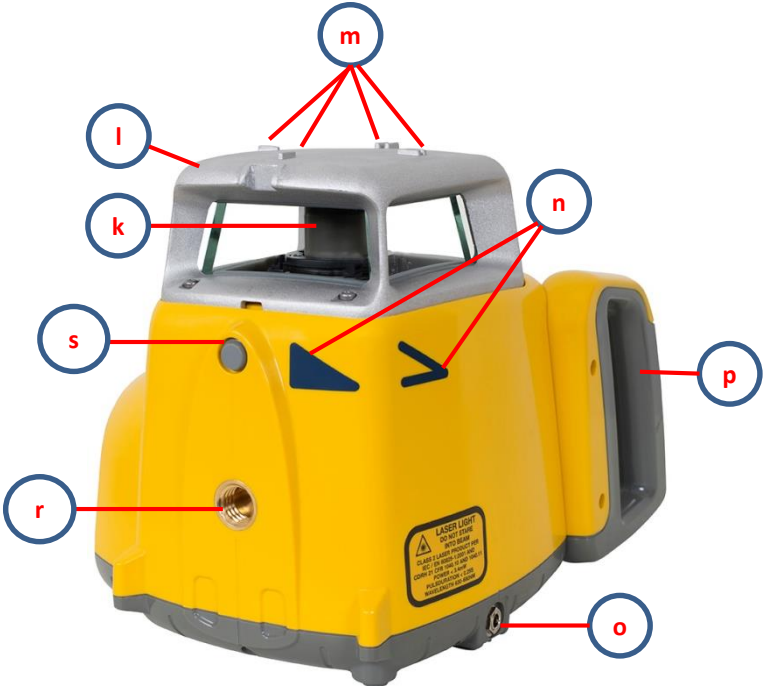
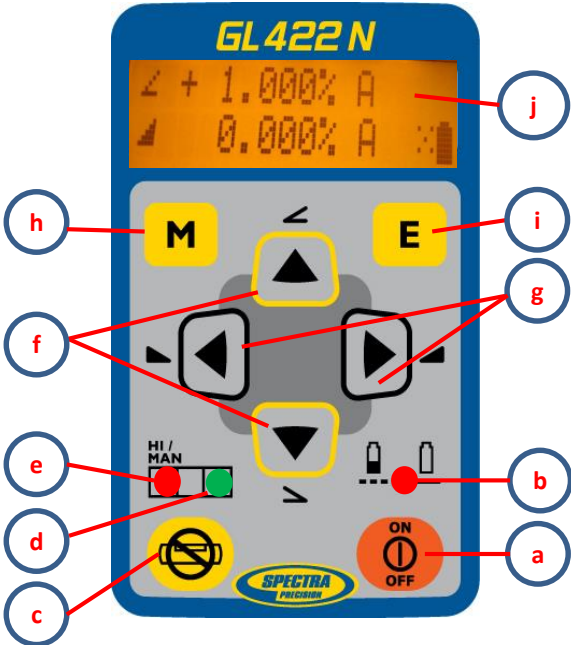

Components

- a Power Button
- b Battery LED
- c Manual/Standby Button
- d Leveling LED
- e Manual/Hi-Warning LED
- f Up and Down Arrow Buttons
- g Left and Right arrow Buttons
- h M – button
- i E - button
- j Liquid Crystal Display (LCD)
- k Rotor
- l Sunshade
- m Sighting Guides
- n Axes-Alignment-Marks
- o Recharge Jack
- p Handle
- q Battery door
- r 5/8x 11 Tripod Mounts
- s Rubber feet

How to Use the Laser System

Powering the Laser

Batteries

WARNING

Ni-MH batteries may contain small amounts of harmful substances.

Be sure to charge the battery before using it for the first time, and after not using it for an extended length of time.

Charge only with specified chargers according to device manufacturer's instructions.

Do not open the battery, dispose of in fire or short circuit; it may ignite, explode, leak or get hot causing personal injury.

Dispose in accordance with all applicable federal, state, and local regulations.

Keep the battery away from children. If swallowed, do not induce vomiting. Seek medical attention immediately.

Powering the GL

- 1 – GL is shipped with a rechargeable NiMH battery pack, it is keyed to prevent mis-insertion.
- 2 – The rechargeable battery pack can be charged inside of the unit
- 3 – Alkaline batteries can be used as a backup
- 4 – Plus and minus symbols at the battery door indicate how to put the alkalines into the battery compartment

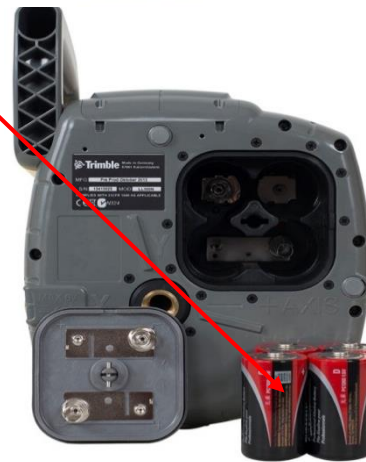
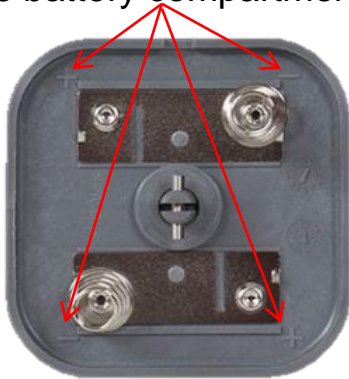

Installing Batteries

Remove the battery door by turning the center screw 90° counterclockwise. Insert batteries (or a rechargeable battery pack) into the housing so that the **negative poles are on the bigger battery spiral springs**.

DO NOT REMOVE RECHARGEABLE BATTERIES FROM THEIR HOLDER AND INSTALL ALKALINE BATTERIES, SEVERE DAMAGE TO UNIT WILL RESULT IF CHARGING IS ATTEMPTED.

Install the battery door and tighten it by turning the center screw 90° clockwise.

A mechanical switch prevents alkaline batteries from being charged. Only the original rechargeable battery pack allows charging within the unit. Any other rechargeable batteries have to be charged externally.

Recharging the Batteries

The laser is shipped with a rechargeable NiMH-battery pack.

Note: The battery LED shows the approximate charge of the batteries.

The LED will flash when battery voltage is between 3.8 and 4.0 volts.

The LED will be on continuously when battery voltage is less than 3.8 volts.

The charger requires approx. 13 hours to charge empty rechargeable batteries.

For charging, connect the plug of the charger to the recharge jack of the unit.

New or long-time out-of-use rechargeable batteries reach their best performance after being charged and recharged five times. For Indoor applications the charger can be used as a power supply for the GL.

Alkaline batteries can be used as a backup. Insert 4 D-cell batteries noting the plus (+) and minus (-) diagrams at the battery door.

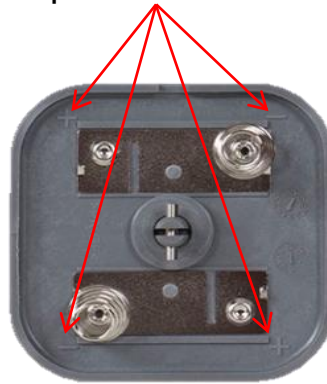

The batteries should only be charged when the laser is between 50° F and 104° F (10°C to 40°C). Charging at a higher temperature may damage the batteries. Charging at a lower temperature may increase the charge time and decrease the charge capacity, resulting in loss of performance and shortened life expectancy.

RC402N Radio Remote Control

Powering the RC402N

1. Open the battery door using a coin or similar pry device to release the battery door tab on the RC402N. RC402N will be shipped with alkaline batteries. Rechargeable batteries can be used optional but need to be charged externally.
2. Insert two AA batteries noting the plus (+) and minus (-) diagrams inside the battery housing.
3. Close the battery door. Push down until it “clicks” into the locked position.



Turning On/Off the Radio Remote Control

The radio remote control is a hand-held device that allows you to send operational commands to the laser from a remote location.

Press the power button to turn on the radio remote control.

Note: When the remote control is initially turned on, the standard display (model number and software version) appear for the first 3 seconds, then the RC402N LCD shows the information as shown at the laser.

With every button press, the LCD backlight is activated and turns off automatically if no button is pressed for 8 seconds.

To turn off the radio remote control, press and hold the power button for 2 seconds.

If the RC402N is outside of the operating range or not paired with the transmitter, the LCD shows the model number and software version.



RC402N V00.503
198.035.234.217

Note: 5 minutes after the last button press, the remote control turns off automatically.

Pairing the remote control with the transmitter

First, make sure the transmitter and the remote control are turned off. Then press and hold the **Manual** button and turn on the transmitter. During the next 6 seconds repeat the same steps on the remote control. The transmitter's displays show the following information:



The transmitter and remote's display show Pairing OK for one second and then the same information as shown at the laser's LCD to indicate the transmitter has been matched with the remote control.

To pair the HL760 receiver with the transmitter

Make sure the transmitter is turned off.

First, turn on the receiver, then press and hold the Deadband (**A**) and Audio (**B**) buttons for two seconds.

After two seconds, the display shows MENU first, then RDIO

Press and release the Enter button – display shows the current radio mode.



or



or

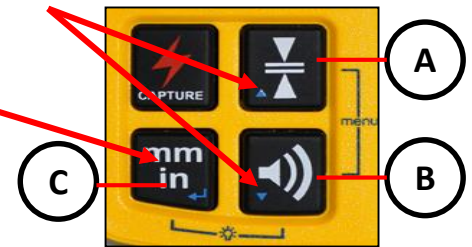

If not already set to **LS**, press Units (**C**) button (current mode flashes) and then press Deadband (**A**) or Audio button (**B**) until **LS** is displayed.



Press Units (**C**) button again to enter selection.

Press and release the Audio (**B**) button – display shows **PAIR**.



Press the Units (**C**) button again – the display shows **PAIR** and a rotating bar.

Then press and hold the **Manual** button and turn on the transmitter (Battery LED flashes fast). After completing **PAIR**, **OK** will be displayed.



The laser pairs now automatically with the new receiver and turns back to the standard function.

Press and release the HL760 Power button two times to exit the menu at the receiver.

A laser symbol and an antenna is lit to confirm the receiver is ready for communication with the laser.



Fingerprint function at the HL760 receiver

Fingerprinting makes sure the HL760 detects only the laser beam of the paired transmitter. Laser fingerprinting is automatically activated and confirmed with a clock symbol after a HL760 has been paired with the laser. To recognize an ignore laser strikes from other than the paired transmitter takes typically 5 seconds; sometimes few seconds more.

Laser Setup

Position the laser horizontally (tripod mount and rubber feet downward!) on a stable platform, wall mount or tripod at the desired elevation.

The laser recognizes automatically whether it is used horizontally or vertically when switched on.

Turning On/Off the laser

Press the power button to turn On/Off the laser.

The LCD shows **Initialisation** and then for one second the **model number** and **Software Rev.**



Initialisation
...

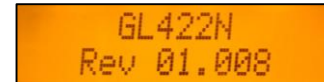

GL422N
Rev 01.008

The LEDs (**b**, **d** and **e**) are turned on for 2 seconds. At the LCD, the last used grade values, the mask mode and battery status will be displayed. The battery symbol disappears after few seconds and comes back if the batteries are getting low.

If a grade value has been dialed in, the unit starts the temperature/reference check while the thermometer symbols are flashing.

When the temperature/reference check has been finished, the standard display appears and the **A** symbols flash until self-leveling has been completed.



∠ + 2.455% A
▲ (□□□) A %

GL412N - horizontal setup - GL422N



∠ + 1.850% ↓
▲ + 2.500% ↓ %



∠ + 1.850% A
▲ + 2.500% A %

GL412N - vertical setup - GL422N



∠ (□□□) A
▲ <-----> %

Pressing and holding the **E** button shows the **actual rotation speed** and the **internal temperature**.

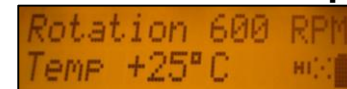

Rotation 600 RPM
Temp +25°C %

Features and Functions

Standard Display

The remote control mirrors the functionality of the laser keypad



Battery status laser

Mask mode indication

M-Button: Quickly press and release **starts the MENU entry** and can be used to return to the previous menu position

E-Button: Quickly press and release starts the selected mode

Manual Button: Quickly press and release activates/deactivates the manual mode

Up/Down Arrow Buttons

Left/Right Arrow Buttons

ON/OFF button - press for 1 second to turn on the unit; press and hold for 2 seconds to turn off the unit

Battery- LED (red)

Leveling- LED (green)

Manual/HI-Warning- LED (red)

HI alert function is activated



Standard Features

Manual mode

Pressing and releasing **Manual** button activates/deactivates the manual mode regardless if set up horizontal or vertical.

Manual mode is indicated by horizontal lines next to the axes symbols and a M.

In Manual mode (horizontal), the Y-axis can be sloped by pressing the **Up-** and **Down-** Arrow buttons on the laser's keypad or the remote control. Additionally, the X-axis can be sloped by pressing the **Left-** and **Right-** Arrow buttons on the laser or remote control.

In vertical mode, the **Up** and **Down** arrow buttons adjust the vertical slope, and the **Left** and **Right** arrow buttons align the laser reference to the right/left side.

To resume automatic self-leveling mode, press the **Manual** button again.



Mask Mode

Mask Mode – allows you to electronically turn off the laser beam (electronic shutters) in up to 3 lighthouse windows to prevent interference with other receivers on the jobsite. Mask Mode can be selected as a standard feature as well as using the menu.

To activate the mask mode on the + or -Y-axis, press the **Up** or **Down** arrow button at the laser or remote control, then within <1 second press and release the **Manual** button.

Press the **Right** or **Left** arrow button in sequence with the **Manual** button to activate/deactivate the mask mode for the + or – X axis

The display indicates which side of the laser the beam has been electronically turned off.



Note: The unit always powers up with the mask mode deactivated (default).

Activating/Deactivating Standby mode

Press and hold the **Manual** button at the laser or remote control for 3 seconds activates the Standby mode.

The self-leveling will be stopped and the beam will be turned off while the HI alert is still active.

The display shows Standby and the HI/MAN-LED flashes red every 5 seconds.



To deactivate Standby mode and restore full operation of the laser, press and hold the

Manual button at the laser or remote control again for 3 seconds.

Line Scan - Vertical Setup

When setting up the unit vertical, Line Scan centers the rotor horizontally and can be used to align the laser reference to a desired line position. Line Scan can be activated as a standard feature as well as using the menu.

Pressing and releasing the **Left/Right** buttons **simultaneously** starts Line Scan while the rotor checks the limits of the X- axis (all laser LEDs are turned off) and stops at the center position.

Pressing the **Manual** button stops the movement and changes the unit into manual mode.

Corrections left and right can be done using **Left/Right** arrow buttons.

Press and release the **Manual** button to change the unit back to full automatic mode.



Menu Functions

Press and release **M** button at the Standard Display to enter the MENU.

The menu offers always only the features which can be selected depending on the setup (horizontal or vertical).

The actual available function will be marked in arrow brackets >> <<.

A down arrow at the the right site indicates that the user can scroll down through the menu using the **down** arrow button.

After going to the next menu row, an up/down arrow at the the right site indicates that the user can scroll up/down through the menu using the **Up/Down** arrows buttons.

Pressing and releasing button **M** changes the unit always back to the standard or previous display.

Press and release the **Up/Down** buttons until the desired function at the selected menu row is marked.

Press and release button **E** to open the submenu OR start the selected function.

Menu functions when set up horizontal (GL4X2N)

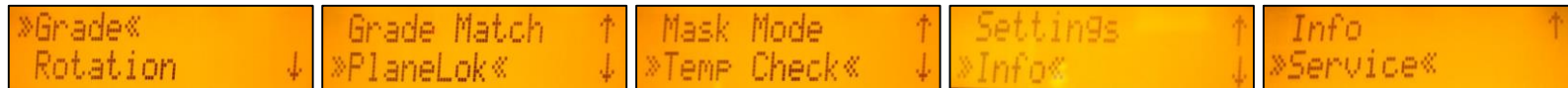

Menu functions when set up vertical (GL4X2N)



Y-X-grade entering Step and Go mode

Quickly press and release button **M** opens the **menu**.

>>Grade<< will be shown.

Press/release button **E** → Both grade values will be shown.

Press/release **M** button → escape/return to the standard display.

Press and hold button **Left** or **Right** to change X- axis grade value (only GL422N) after the comma; press and hold buttons **Left + Right** simultaneously starts X-axis quick change mode where the grade value in front of the comma will be set to 0% and then starts changing in 1% increments.

Press and hold button **Up** or **Down** for changing Y -axis grade value; press and hold buttons **Up + Down** simultaneously starts Y- axis quick change mode where the grade value in front of the comma will be set to 0% and then starts changing in 1% increments.

Note: An asterisk at the right side indicates which grade value will be changed. The speed of the grade value change increases with the amount of time the button is held down.

Note: The grade value for both axes increases in 1.00% increments. When the grade value for either axis reaches its highest amount, the grade value switches to the lowest value for that axis. For example, the value switches from +15% to -10%.

The laser will self-level to the required grade position after confirming the grade change with button **E**.

Note: The **A** symbols at the LCDs will flash until the laser has been self-leveled to the requested grade position.

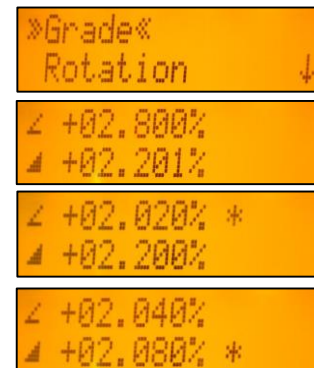

Y-X-grade entering Digit Select mode (Default)

Quickly press and release button **M** opens the **menu**.

>>**Grade**<< will be shown.

Press/release button **E** → Both grade values will be shown and a cursor flashes at the +Y sign.

Press/release **M** button → escape/return to the standard display.

Pressing and releasing **Right** or **Left** button moves the cursor to the right/left and in a circle to the next row.

Use **Down** or **Up** button to change the sign (grade reverse) and set the desired digit.

For a quick cursor toggle between the X-(only GL422N) and Y-axis, press and release **Manual** button.

Press and hold the **Manual** button for 2 seconds sets the grade to 0%.

Quickly press and release button **E** to confirm the selected grade value and return to the standard display. The laser will self-level to the required grade position.

Note: The **A** symbols at the LCD's will flash until the laser has been self-leveled to the requested grade position.

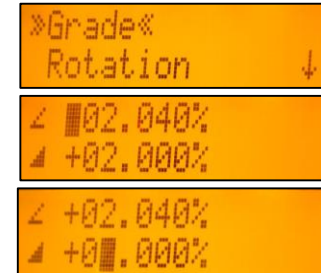

Selecting the Rotation speed

Quickly press and release button **M** opens the **menu**.

Repeatedly press the **down** arrow button until **>>Rotation<<** will be marked.

Press/release button **E** → Both rotation values will be shown.

Repeatedly pressing buttons **Up/Down** toggles between 300 and 600 rpm (Default) regardless if the unit is in automatic or manual mode.

Quickly press and release button **E** to confirm the selected rotation speed.

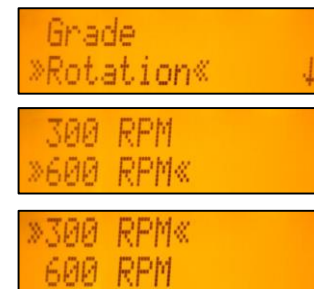

Automatic Grade Match

The Grade Match mode can be activated in horizontal automatic mode.

In Grade Match mode, the laser can be used to measure the existing grade value between two known elevation points (up to 100 m (330 ft) located on the Y-axis of the laser).

1. Set up the laser over the reference point.
2. Attach the HL760 receiver to a grade rod. Check the laser's elevation next to the laser then position the receiver at the second point **WITHOUT** changing the receiver's elevation on the rod.
3. Use the sighting guides on the top of the laser to align the laser to the receiver.
Turn the laser on the tripod until it is roughly aligned to the receiver's position
4. Press and release the **M** button at the Standard Display and select **>>Grade Match<<**.
5. Press and release the **E** button to open the Grade Match submenu; select the Y-axis then press the **E** button to start Grade Match.

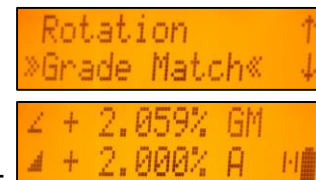
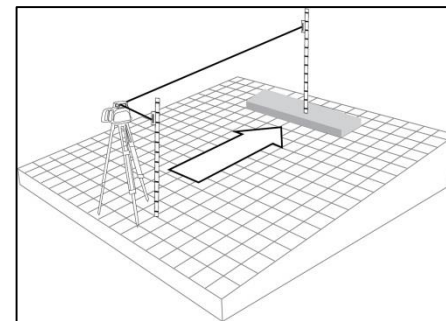

Note: The laser starts to search for the receiver. The HL760 display shows a flashing **-GM-** during the time the laser is searching and adjusting the beam to the on-grade position. When Grade Match has been completed, the HL760 goes back to the standard elevation display. The remote control as well as the laser will display the final measured grade value. Exiting of Grade Match can be done by pressing the **Manual** button where the unit goes always back to automatic mode.



Automatic PlaneLok mode

The PlaneLok mode can be activated in horizontal automatic and vertical automatic and manual mode. In PlaneLok mode when set up horizontal, the beam will be locked to a fixed elevation point (up to 100 m (330 ft) located on the Y-axis of the laser. For keeping vertical alignments fixed to the direction or slope positions, PlaneLok can be used on the Z- (only GL422N) or X-axis.

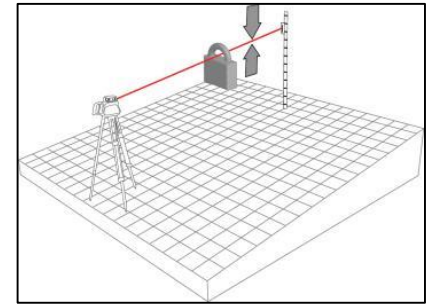

1. Set up the laser over the reference point.
2. Attach the HL760 receiver to a grade rod. Place the receiver at the second point and adjust it to the On-grade position. The receiver should be permanently mounted at this location and at the desired elevation.
3. Use the sighting guides on the top of the laser to align the laser to the receiver. Turn the laser on the tripod until it is roughly aligned to the receiver's position.
4. Press and release the **M** button at the Standard Display and select **>>PlaneLok<<**.
5. Press and release button **E** to open the PlaneLok submenu; select the Y-axis when set up horizontally or the X-axis when set up vertically; then press the **E** button to start PlaneLok.

A screenshot of the laser's LCD display. It shows the text "Grade Match" with an upward-pointing arrow and "PlaneLok" with a downward-pointing arrow.

Note: The laser starts to search for the receiver. The HL760 display shows a flashing **-PL-** during the time the laser is searching and adjusting the beam to the on-grade position. When PlaneLok is complete, **-PL-** stops flashing at the HL760 and RC402N display.

A screenshot of the laser's LCD display showing "PL Y" in a yellow box.

When setting up the transmitter vertical, PlaneLok can be used at the Z- or X-axis.

A screenshot of the laser's LCD display showing "PL" with a dashed line and "+ 2.000% A H" below it.

1. Press and release the **M** button at the Standard Display and select **>>PlaneLok<<**.
2. Press and release button **E** to open the PlaneLok submenu; select the **Z**-axis (only GL422N) or the **X**-axis; then press button **E** to start PlaneLok.

A screenshot of the laser's LCD display showing "PL Z" and "PL X" in a yellow box.

Note: When used in **vertical mode**, the receiver has to be placed with the **photocell on the bottom side**; for **Z-PlaneLok**, align the **top of the receiver to the top of the laser**. For getting the best performance and a longer operating range set up the HL760 at least 0.5 m (2 ft) above the ground.

A screenshot of the laser's LCD display showing "PL Z" and "PL X" in a yellow box.

Note: In every PlaneLok mode the laser continues to servo to the receiver's signals. Any loss of signal over an extended period of time (1 minute) causes the laser to go into the HI-alert condition (beam turns off, rotor stops and a warning message occurs at the LCD). PlaneLok mode can be reactivated after the Error message has been deleted with the **E** button.

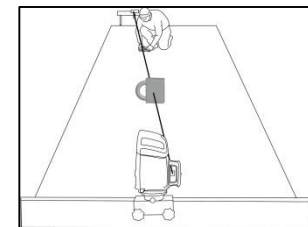

A screenshot of the laser's LCD display showing "Error" and "037-062-140" in a yellow box.

Exiting of PlaneLok can be done by pressing **Manual** button or any HL760 button.

Mask mode

Press and release the **M** button at the Standard Display and select **>>Mask Mode<<**.

Depending on which side the beam should be turned off, the required side can be selected. Press and release the **E** button, the mask symbol occurs.

For selecting the side, press and release one of the arrow buttons.

When all areas have been set, press button **E** to store the mask sector selection until the unit will be turned off.

Note: The unit always powers up with the mask mode deactivated (default).

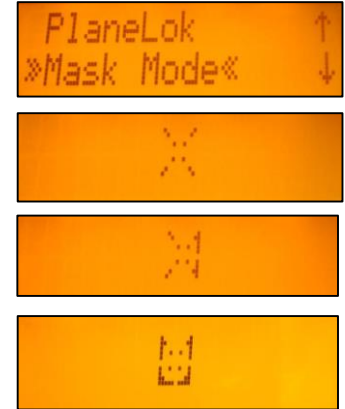

Start Temperature (Reference) Check

Before starting some grade work which is very sensitive an additional Reference Check can be started manually. Press and release the **M** button at the Standard Display and select **>>Temp Check<<**.

Pressing and releasing the **E** button starts the Reference Check considering the current temperature inside the housing.

While the rotor checks the correct position the rotation will be stopped.

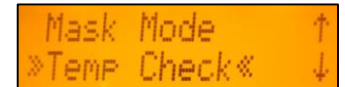

Setting Menu

Please see the Setting Menu details at the following pages.



Info

Press and release the **M** button at the Standard Display and select **>>Info<<**.

Up and **Down** Buttons can be used to toggle between **About LS**, **Runtime** and **Radio**

Press and release button **E** to confirm the selection.

The laser information (software version, serial number.), the runtime of the GL or the radio channel will be displayed.



Service

Press and release the **M** button at the Standard Display and select **>>Service<<**.

Buttons **Up/Down** can be used to toggle between **Calibration X** and **Calibration Y** OR **Calibration Z** when set up vertically.

Press and release button **E** to confirm the selection.

The calibration at the selected axis starts the field calibration procedure.



Line Scan

When setting up the unit vertical, Line Scan centers the rotor horizontally and can be used to align the laser reference to a desired line position.

Press and release the **M** button at the Standard Display and select **>>Line Scan<<**.

Press and release button **E** to start Line Scan.

The rotor checks the limits of the X- axis (**LS** is flashing; all laser LEDs are turned off) and stops at the center position.

Pressing the **Manual** button stops the movement and changes the unit into manual mode.

Corrections left and right can be done using **Left/Right** arrow buttons.

Press and release the **Manual** button to change the unit back to full automatic mode.

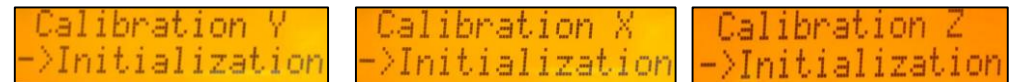

Setting Menu

Press and release the **M** button at the Standard Display and select **>>Settings<<**.



Press and release button **E** to open the Setting Menu; select the desired function then press button **E** to open the selected submenu function OR start the selected function.

HI-alert Selection

Select **HI Alert** and press and release button **E** to open the HI-Alert menu.



The desired HI-alert: **5 min.**(Default), **30 seconds** and **HI-off**) can be selected using the **Up/Down** buttons.



Press and release button **E** to confirm the selected HI-alert.



Grade Entry

Select **>>Grade Entry<<** and press and release button **E** to open the Grade Entry menu.

Up/Down Buttons can be used to toggle between **Digit Select** and **Step and Go** .



Press and release button **E** to confirm the selection.

Grade Display

Select **>>Grade Display<<** and press and release button **E** to open the Grade Display menu.



The desired Grade Display Mode (**Percent/ Per mille/Degree**) can be selected using the **Up/Down** buttons.



Press and release button **E** to confirm the selected display mode.

Sensitivity Selection

Select >>**Sensitivity**<< and press and release button **E** to open the Sensitivity menu.

The desired Sensitivity: **Low**, **Middle**(Default) and **High**) can be selected using the **Up/Down** buttons.



Press and release button **E** to confirm the selected Sensitivity.

Select Language

Select >>**Language**<< and press and release button **E** to open the Language menu.

Use **Up/Down** buttons to select the required local language (EN, DE, IT, FR, ES, PT, NL, DA, NO, SV, FI, PL, TR, CZ).

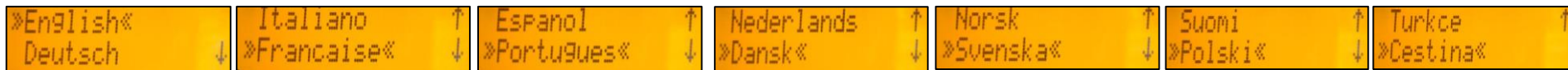
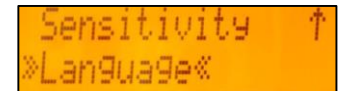

Press and release button **E** to store the selected Language; unit falls back to the standard menu.

Radio Channel

Select >>**Radio Channel**<< at the laser and press and release button **E** to open the Radio Channel menu.

The desired Radio Channel: 0 to 5 can be selected using the **Up/Down** buttons.



Press and release button **E** to confirm the selected Radio Channel.

After changing the Radio channel, **the RC and HL needs to be paired again.**

Troubleshooting

Any error message can be deleted with a short press of button **E**. The table shows the related description and possible solutions.

The next service center should be contacted if a different error message as shown at the table will be displayed.

Error codes	Description	Solution
21	Temporary EEprom problem	Press the E button to delete the error message
120	HI alert - Unit Height changed	Check laser beam elevation
130	Mechanical Limit during Grade Match / PlaneLok	Check if existing slope is above +/-9%
140	Laser beam blocked	Make sure there are no obstacles between the transmitter and the HL760
141	Time Out - Alignment could not be completed in the allowed time	Check radio operating range/ connection; check stable laser setup
150	No receiver – HL760 Receiver not available for single axis automatic function	Make sure the HL760 is on and paired
152	No receiver - The laser searched for the receiver but could not find it	Check the operating range for auto function and restart the auto alignment
153	Lost Receiver - The laser searched and found the receiver but then lost it	Check the operating range for auto function and restart the auto alignment
155	More than two paired receivers are available during automatic alignment function.	Make sure only two receivers are turned on.
160	X or Y level sensor defect	Contact service center

CALIBRATION

Checking Calibration of the Y- and X-Axes

1. Set up the laser 30 m (100 ft) from a wall and allow it to level.
2. Allow the unit to warm up for 20 minutes.
3. Set the grade to 0.000% in both axes.
4. Raise/lower the receiver until you get an on-grade reading for the +Y axis. Using the on-grade marking notch as a reference, make a mark on the wall.

Note: For increased precision, use the fine-sensitivity setting (1.5 mm/ 1/16 in.) on the receiver.

5. Rotate the laser 180° (-Y axis toward the wall) and allow the laser to re-level.
6. Raise/lower the receiver until you get an on-grade reading for the -Y/axis. Using the on-grade marking notch as a reference, make a mark on the wall.
7. Measure the difference between the two marks. If they differ more than 3 mm at 30 m (1/8 inch at 100 feet), the laser needs calibrating.
8. After checking the Y-axis, rotate the laser 90°. Repeat the above starting with the + X axis facing the wall.

Checking Calibration of the Z-(vertical) Axis

To check vertical calibration, you need a plumb bob with at least 10m (30ft) of string.

1. Suspend the plumb bob in front of a house i.e., attached to a window frame whose window height is at least 10m (30ft).
2. Set up the laser in vertical so that the laser beam strikes the receiver's on-grade position at the top of the string.
3. Look for any deviation using the receiver from the top of the string to the bottom of it. If the deviation is more than 1mm (<1/16 in.), the vertical axis needs calibrating.

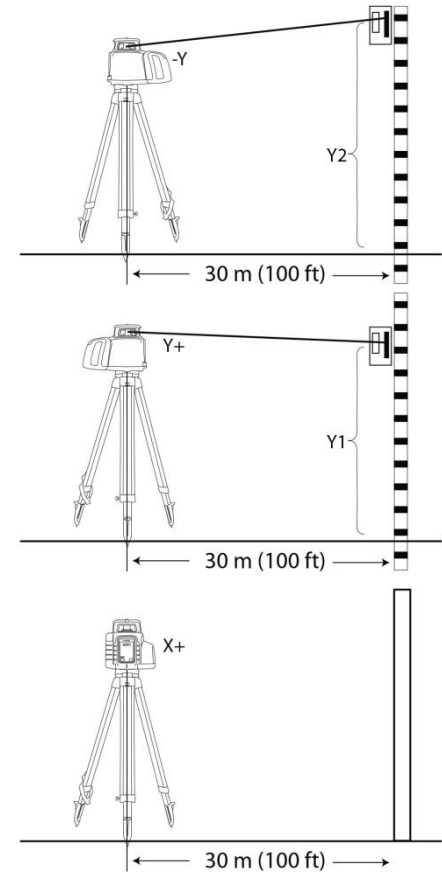

PROTECTING THE UNIT

Do not expose the unit to extreme temperatures or temperature changes (do not leave inside the car). The unit is very robust and can resist damage if dropped even from tripod height. Before continuing your work, always check the leveling accuracy. See **Checking Calibration** section. The laser is water proof and can be used indoors and outdoors.

CLEANING AND MAINTENANCE

Dirt and water on the glass parts of laser or prism will influence beam quality and operating range considerably. Clean with cotton swabs. Remove dirt on the housing with a lint-free, warm, wet and smooth cloth. Do not use harsh cleansers or solvents. Allow the unit to air dry after cleaning it.

PROTECTING THE ENVIRONMENT

The unit, accessories and packaging ought to be recycled. All plastic parts are marked for recycling according to material type.



Do not throw used batteries into the garbage, water or fire. Remove them in compliance with environmental requirements.

Notice to Our European Union Customers

For product recycling instructions and more information, please go to:

http://www.trimble.com/Corporate/Environmental_Compliance.aspx

Instructions for Return to ERFC:

- WEEE is to be shipped to the ERFC, clearly stating WEEE on the delivery note and / or packaging
- Specific product number and serial number information is not required
- Additional return authorisation from Trimble Support is not required
- Delivery Address:

Trimble Europe B.V. WEEE Recycling
C/O Menlo logistics
Gate 19 to 26
Meerheide 43
5521 DZ Eersel
The Netherlands



Confirmation of receipt of the returned WEEE will not be provided by the ERFC

Warranty

Trimble warrants the GL422N/GL412N to be free of defects in material and workmanship for a period of five years. Trimble or its authorized service center will repair or replace, at its option, any defective part, or the entire product, for which notice has been given during the warranty period. If required, travel and per diem expenses to and from the place where repairs are made will be charged to the customer at the prevailing rates. Customers should send the product to Trimble Inc. or the nearest authorized service center for warranty repairs or exchange, freight prepaid. Any evidence of negligent, abnormal use, accident, or any attempt to repair the product by other than factory-authorized personnel using Trimble certified or recommended parts, automatically voids the warranty. Special precautions have been taken to ensure the calibration of the laser; however, calibration is not covered by this warranty. Maintenance of the calibration is the responsibility of the user.

The foregoing states the entire liability of Trimble regarding the purchase and use of its equipment. Trimble will not be held responsible for any consequential loss or damage of any kind. This warranty is in lieu of all other warranties, except as set forth above, including any implied warranty merchantability of fitness for a particular purpose, are hereby disclaimed. This warranty is in lieu of all other warranties, expressed or implied.

TECHNICAL DATA

Laser

Leveling accuracy^{1,3}:

Grade accuracy^{1,3}:

Grade temperature drift sensitivity:

Grade range⁴:

Rotation speed:

Operational area^{1,2}:

Laser type:

Laser class:

Self-leveling range:

Leveling indicators:

Radio range (HL760):

Power source:

Battery life¹:

Operating temp.:

Storage temp.:

Tripod attachments:

Dust and Water proof:

Weight:

Low voltage indication:

Low voltage disconnection:

1) *at 21° Celsius*

2) *under optimal atmospheric circumstances*

3) *along the axis*

4) *pre-tilt above 9%*

± 1.5 mm/30 m, 1/16" @ 100 ft, 10 arc seconds

± 3.0 mm/30 m, 1/8" @ 100 ft, 20 arc sec

± 0,9 mm/30 m / 1°C; 1/16" @ 310 ft. @ 1°F

-10% to +15% (Dual Axes GL422N)

-10% to +15% (Single Axis GL412N)

300, 600 rpm

appr. 400 m (1300 feet) radius with detector

red diode laser 650 nm

Class 2, <3.4 mW

appr. ± 5° (±9%)

LCD indications and LED flashes

up to 100 m (330 ft)

10000mAh NiMH battery pack

35 hours NiMH; 50 hours alkaline

-20°C to 50°C (-4°F to 122°F)

-20°C to 70°C (-4°F to 158°F)

5/8 x 11 horizontally and vertically

IP66

3.1 kg (6.8 lbs)

LCD and LED battery indicator

unit shuts off

TECHNICAL DATA

Remote Control RC402N

Radio operating range ¹ :	up to 100 m (330 ft)
Power source:	2 x 1.5V AA alkaline batteries
Battery life ¹ :	130 hours
Dust and Water proof:	IP66
Weight (incl. Batteries):	0.26 kg (0.57 lbs)

DECLARATION OF CONFORMITY

Please disregard the declaration of conformity within the manual.

Following is the valid declaration:

We

Trimble Kaiserslautern GmbH

Declare under our sole responsibility that the products

GL422N/GL412N and RC402N

To which this declaration relates is in conformity with the following standards:

EN300 440-2 V1.1.1:2004, EN301 489-03 V1.4.1:2002, EN301 489-01 V1.4.1:2002, EN50371:2002

following the provisions of directive **R&TTE 1999/5/EC**

The managing director

Electro-Magnetic Compatibility

Compliance statement (part 15.19) This device complies with part 15 of the FCC Rules. Operation is subject to the following two conditions: (1) this device may not cause harmful interference, and (2) this device must accept any interference received, including interference that may cause undesired operation. Warning (part 15.21) Changes or modifications not expressly approved by the party responsible for compliance could void the user's authority to operate the equipment. This in particular is applicable for the antenna which has been delivered with the GL422/GL412 and RC402N Under Industry Canada regulations, this radio transmitter may only operate using an antenna of a type and maximum (or lesser) gain approved for the transmitter by Industry Canada. To reduce potential radio interference to other users, the antenna type and its gain should be so chosen that the equivalent isotropically radiated power (e.i.r.p.) is not more than that necessary for successful communication.

Spectra Precision Laser GL412N/GL422N

User Guide

Contact Information:

AMERICAS

Trimble - Spectra Precision Division

5475 Kellenburger Road
Dayton, Ohio 45424 • USA
Toll Free +1-888-272-2433
Fax +1-937-245-5489

www.spectralasers.com

© 2018 Trimble Inc.. All rights reserved. Spectra Precision is a Division of Trimble Inc.,
Spectra Precision and the Spectra Precision logo are trademarks of Trimble Inc. or its subsidiaries. P/N 101178-00 Rev. C

Contractors-Tools.com

Call 1-877-866-5721

