

GL700 Series Laser Transmitter

User Guide



Single Grade
Dual Grade

www.trimble.com

Contractors-Tools.com
 **1-877-866-5721**

GL700 Series Laser Transmitter

User Guide



**Version 3.75
Revision C
Part Number 1445-0100
September 2007**

Corporate Office

Trimble Construction Division
5475 Kellenburger Road
Dayton, Ohio 45424-1099
U.S.A.

Copyright and Trademarks

Copyright © 2002–2007, Trimble Navigation Limited. All rights reserved.

Trimble, and the Globe & Triangle logo are trademarks of Trimble Navigation Limited, registered in the United States Patent and Trademark Office. Spectra Precision is a trademark of Trimble Navigation Limited. All other trademarks are the property of their respective owners.

Release Notice

This is the September 2007 release (Revision C) of the *GL700 Series Laser Transmitter User Guide*, part number 1445-0100. It applies to version 3.75 of the GL700 Series Laser Transmitter.

The following limited warranties give you specific legal rights. You may have others, which vary from state/jurisdiction to state/jurisdiction.

Hardware Limited Warranty

Trimble Navigation Limited warrants that this hardware product (the "Product") will perform substantially in accordance with published specifications and be substantially free of defects in material and workmanship for a period of two (2) years starting from the date of delivery. The warranty set forth in this paragraph shall not apply to software products.

Software License, Limited Warranty

This Trimble software product, whether provided as a stand-alone computer software product, built into hardware circuitry as firmware, embedded in flash memory, or stored on magnetic or other media, (the "Software") is licensed and not sold, and its use is governed by the terms of the relevant End User License Agreement ("EULA") included with the Software. In the absence of a separate EULA included with the Software providing different limited warranty terms, exclusions and limitations, the following terms and conditions shall apply. Trimble warrants that this Trimble Software product will substantially conform to Trimble's applicable published specifications for the Software for a period of ninety (90) days, starting from the date of delivery.

Warranty Remedies

Trimble's sole liability and your exclusive remedy under the warranties set forth above shall be, at Trimble's option, to repair or replace any Product or Software that fails to conform to such warranty ("Nonconforming Product") or refund the purchase price paid by you for any such Nonconforming Product, upon your return of any Nonconforming Product to Trimble in accordance with Trimble's standard return material authorization procedures.

Warranty Exclusions and Disclaimer

These warranties shall be applied only in the event and to the extent that (i) the Products and Software are properly and correctly installed, configured, interfaced, maintained, stored, and operated in accordance with Trimble's relevant

operator's manual and specifications, and; (ii) the Products and Software are not modified or misused. The preceding warranties shall not apply to, and Trimble shall not be responsible for defects or performance problems resulting from (i) the combination or utilization of the Product or Software with hardware or software products, information, data, systems, interfaces or devices not made, supplied or specified by Trimble; (ii) the operation of the Product or Software under any specification other than, or in addition to, Trimble's standard specifications for its products; (iii) the unauthorized modification or use of the Product or Software; (iv) damage caused by accident, lightning or other electrical discharge, fresh or salt water immersion or spray; or (v) normal wear and tear on consumable parts (e.g., batteries). Trimble does not warrant or guarantee the results obtained through the use of the Product.

THE WARRANTIES ABOVE STATE TRIMBLE'S ENTIRE LIABILITY, AND YOUR EXCLUSIVE REMEDIES, RELATING TO PERFORMANCE OF THE PRODUCTS AND SOFTWARE, EXCEPT AS OTHERWISE EXPRESSLY PROVIDED HEREIN, THE PRODUCTS, SOFTWARE, AND ACCOMPANYING DOCUMENTATION AND MATERIALS ARE PROVIDED "AS-IS" AND WITHOUT EXPRESS OR IMPLIED WARRANTY OF ANY KIND BY EITHER TRIMBLE NAVIGATION LIMITED OR ANYONE WHO HAS BEEN INVOLVED IN ITS CREATION, PRODUCTION, INSTALLATION, OR DISTRIBUTION INCLUDING, BUT NOT LIMITED TO, THE IMPLIED WARRANTIES OF MERCHANTABILITY AND FITNESS FOR A PARTICULAR PURPOSE, TITLE, AND NONINFRINGEMENT. THE STATED EXPRESS WARRANTIES ARE IN LIEU OF ALL OBLIGATIONS OR LIABILITIES ON THE PART OF TRIMBLE ARISING OUT OF, OR IN CONNECTION WITH, ANY PRODUCTS OR SOFTWARE. SOME STATES AND JURISDICTIONS DO NOT ALLOW LIMITATIONS ON DURATION OR THE EXCLUSION OF AN IMPLIED WARRANTY, SO THE ABOVE LIMITATION MAY NOT APPLY TO YOU.

TRIMBLE NAVIGATION LIMITED IS NOT RESPONSIBLE FOR THE OPERATION OR FAILURE OF OPERATION OF GPS SATELLITES OR THE AVAILABILITY OF GPS SATELLITE SIGNALS.

Limitation of Liability

TRIMBLE'S ENTIRE LIABILITY UNDER ANY PROVISION HEREIN SHALL BE LIMITED TO THE AMOUNT PAID BY YOU FOR THE PRODUCT OR SOFTWARE LICENSE. TO THE MAXIMUM EXTENT PERMITTED BY APPLICABLE LAW, IN NO EVENT SHALL TRIMBLE OR ITS SUPPLIERS BE LIABLE FOR ANY INDIRECT, SPECIAL, INCIDENTAL OR CONSEQUENTIAL DAMAGES WHATSOEVER UNDER ANY CIRCUMSTANCE OR LEGAL THEORY RELATING IN ANY WAY TO THE PRODUCTS, SOFTWARE AND ACCOMPANYING DOCUMENTATION AND MATERIALS, (INCLUDING, WITHOUT LIMITATION, DAMAGES FOR LOSS OF BUSINESS PROFITS, BUSINESS INTERRUPTION, LOSS OF BUSINESS INFORMATION, OR ANY OTHER PECUNIARY LOSS), REGARDLESS WHETHER TRIMBLE HAS BEEN ADVISED OF THE POSSIBILITY OF ANY SUCH LOSS AND REGARDLESS OF THE COURSE OF DEALING WHICH DEVELOPS OR HAS DEVELOPED BETWEEN YOU AND TRIMBLE. BECAUSE SOME STATES AND JURISDICTIONS DO NOT ALLOW THE EXCLUSION OR LIMITATION OF LIABILITY FOR CONSEQUENTIAL OR INCIDENTAL DAMAGES, THE ABOVE LIMITATION MAY NOT APPLY TO YOU.

NOT WITHSTANDING THE ABOVE, IF YOU PURCHASED THIS PRODUCT OR SOFTWARE IN THE EUROPEAN UNION, THE ABOVE WARRANTY PROVISIONS MAY NOT APPLY. PLEASE CONTACT YOUR DEALER FOR APPLICABLE WARRANTY INFORMATION.

Notices

Class B Statement – Notice to Users. This equipment has been tested and found to comply with the limits for a Class B digital device, pursuant to Part 15 of the FCC rules. These limits are designed to provide reasonable protection against harmful interference in a residential installation.

This equipment generates, uses, and can radiate radio frequency energy and, if not installed and used in accordance with the instructions, may cause harmful interference to radio communication. However, there is no guarantee that interference will not occur in a particular installation. If this equipment does cause harmful interference to radio or television reception, which can be determined by turning the equipment off and on, the user is encouraged to try to correct the interference by one or more of the following measures:

- Reorient or relocate the receiving antenna.
- Increase the separation between the equipment and the receiver.
- Connect the equipment into an outlet on a circuit different from that to which the receiver is connected.
- Consult the dealer or an experienced radio/TV technician for help.

Changes and modifications not expressly approved by the manufacturer or registrant of this equipment can void your authority to operate this equipment under Federal Communications Commission rules.

Warranty

Trimble warrants the GL700 series lasers, radio remote control, and receiver to be free of defects in material and workmanship for a period of two years. This warranty period is in effect from the date the system is delivered by Trimble or its authorized Dealer to the purchaser, or is put into service by a Dealer as a demonstrator or rental component.

Additionally, items covered by the standard Trimble one-year warranty are the accessories. All other components not manufactured by Trimble but sold as a part of the system such as tripods and grade rods, will carry a 90-day warranty or the manufacturer's warranty, whichever is greater.

Trimble or its Authorized Service Center will repair or replace, at its option, any defective part of components of which notice has been given during the warranty period. A Warranty Registration Card must be filled out properly and on file with Trimble Service Department before warranty repair or replacement can be approved. Travel and per diem expenses, if required, to and from the place where repairs are made will be charged to the purchaser at the prevailing rates.

Customers should send products to the nearest Authorized Factory Service Center for warranty repairs, freight prepaid. In countries with Trimble Subsidiary Service Centers, the repaired products will be returned to the customer, freight prepaid.

Any evidence of negligent, abnormal use, accident, or any attempt to repair equipment by other than factory-authorized personnel using Trimble certified or recommended parts, automatically voids the warranty.

Special precautions have been taken to ensure the calibration of the laser; however, calibration is not covered by this warranty. Maintenance of the calibration is the responsibility of the user.

The foregoing states the entire liability of Trimble regarding the purchase and use of its equipment. Trimble will not be held responsible for any consequential loss or damage of any kind.

This warranty is in lieu of all other warranties, except as set forth above, including an implied warranty merchantability of fitness for a particular purpose, are hereby disclaimed.

Notice to Our European Union Customers

For product recycling instructions and more information, please go to: www.trimble.com/environment/summary.html

Recycling in Europe

To recycle Trimble WEEE,
call: +31 497 53 2430, and
ask for the "WEEE associate," or

mail a request for recycling instructions to:

Trimble Europe BV
c/o Menlo Worldwide Logistics
Meerheide 45
5521 DZ Eersel, NL



EMC Declaration of Conformity

This laser has been tested and found to comply with the limits for a Class B digital device for radio noise for digital apparatus set out in the Radio Interference Regulations of the Canadian Department of Communication, and is pursuant to part 15 of the Federal Communication Commission (FCC) rules. These limits are designed to provide reasonable protection against harmful interference in a residential installation. This laser generates radio frequency. If it is not used in accordance with the instructions, it may cause harmful interference to radio or television reception. Such interference can be determined by turning the laser off and on. You are encouraged to try eliminating the interference by one or more of the following measures:

- Reorient or relocate the receiving antenna.
- Increase the separation between the laser and the receiver.

For more information, consult your dealer or an experienced radio/television technician.



Caution – Changes or modifications to the laser that are not expressly approved by Trimble could void authority to use the equipment.

Application of Council Directive(s):	1995/5/EC and 1973/23/EEC
Manufacturer's Name:	Trimble
Manufacturer's Address:	5475 Kellenburger Road Dayton, Ohio 45424-1099 U.S.A.
European Representative Address:	Trimble GmbH Am Prime Parc 11 65479 Raunheim, Germany GL710, 720, 722, and 742
Model Number(s):	
Conformance to Directive(s):	1999/5/EC using EN300386:1994, EN300328:1996, EN61000-6-2:1999, and EN61010-1:2001; 1973/23/EEC using EN60825-1-A2:2001 and EN60825-1-A11:1996.
Equipment Type/Environment:	ITE/residential, commercial and light industrial
Product Standards:	EN300386:1994, EN300328:1996, EN61000-6-2:1999, EN61010-1:2001, EN60825-1-A2:2001, EN60825-1-A11:1996.

Safety Information

The IEC and the United States Government Center of Devices for Radiology Health (CDRH) has classified these laser as Class 2 (658 nm, visible beam on standard models), and Class 1 (785 nm, infrared beam on IR models) laser products.

Operation

For detailed installation and operating instructions, follow the instructions given in this manual for this laser. The maximum radiant power output of this laser is less than 5 mW.

Controls

Controls are listed in the operation section of this manual.



Caution – Use of controls or adjustments performance of procedures other than those specified herein may result in higher dosage of laser exposure.

This laser complies with all applicable portions of CDRH 21 CFR 1040.10 and 1040.11 of the code of Federal Regulations, Department of Health and Human Services, Food and Drug Administration (Federal Register, Volume 50, Number 161, August 20, 1985).

Protective eyewear

This laser complies with OSHA Standards Act Section 1518.54 for use without eye protection devices. Consequently, protective eyewear is neither required nor recommended. As with any visible laser device, the following safety rules should be observed:

- Never look directly into a laser beam or point the beam into the eyes of others. Set the laser at a height that prevents the beam from shining directly into people's eyes.
- Do not remove any warning signs from the laser.
- Use of this product by people other than those trained on this product may result in exposure to hazardous laser light.
- If initial service is required, which results in the removal of the outer protective cover, removal must only be performed by factory-trained personnel.

Cautions and Notes

Included in this manual are **CAUTIONS** and **Notes**. Each of these words represents a level of danger or concern.

A **CAUTION** indicates a hazard or an unsafe practice that could result in minor injury or property damage.

A **Note** indicates important information unrelated to safety.

Questions about laser safety should be addressed to:

Trimble Construction Division

5475 Kellenburger Road

Dayton, Ohio 45424-1099 U.S.A.

Attention: Quality Assurance Group, Laser Safety Officer

Labels required for this product

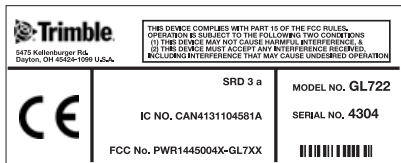
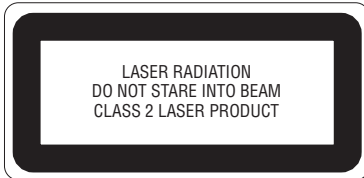
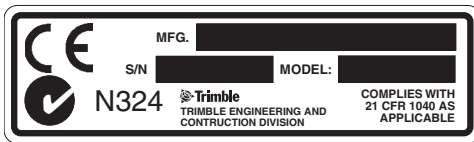

This ISM device complies with Canadian ICES-001.

Cet appareil ISM est conforme a_ la norme NMB-001 du Canada.

This device is intended to be used in the following Member States: Belgium, Germany, France, Italy, Luxembourg, the Netherlands, Denmark, Ireland, the United Kingdom, Greece, Spain, Portugal, Austria, Finland and Sweden. The alert symbol on the CE label indicates that while this device is declared compliant with relevant EU requirements, some geographical restrictions apply in France. Regulations are in a state of flux and the user is urged to contact local French authorities for details.

This device is a “Class 2” radio device in all member States.

Contents

Safety Information

Operation	v
Controls	v
Protective eyewear	v
Cautions and Notes	vi

1 Introduction

Claim for Damage in Shipment	2
Owner's Record	2

2 Features and Functions

Laser	3
Two-Way Radio Remote Control (Radio equipped lasers only)	6
Accessories	8
Connector cable	8
Remote holster	9
Battery recharger	9
M100 3½-8 Adapter	10
M102 Quick-disconnect adapter	10
M103 Steep-grade adapter	10
1243 Sighting scope (GL710 and GL720 only)	10
External power cable.	10

3 How to Use the Laser System

Powering the Laser – Batteries	11
Recharging the batteries.	12
Installing/removing the batteries	13
Powering the Laser – External Cable.	14
Connecting/disconnecting the external power cable.	14
Learning the Basic Laser Functions	15
Turning on/off the laser	15
Selecting the rotation speed	16

	Changing the grade value	16
	Activating/deactivating manual mode	17
	Rotating the axis alignment manually	17
	Two-Way Radio Remote Control (Radio equipped lasers only)	18
	Installing/removing the radio remote control batteries	18
	Learning basic radio remote control functions	20
4	System Setup	
	General Setup Information	27
	Getting Connected	28
	Laser	28
	Radio remote control	30
	Setting Up the Laser System	31
	Setting up the laser in manual mode	31
	Aligning the axis manually	32
	Setting up the laser in vertical mode	33
	Establishing Control	33
	Determining height of instrument (HI)	33
	Establishing elevation-control hubs	34
	Establishing grade-control hubs	34
	Reversing the Grade (Two-way radio remote control)	35
5	Automatic Alignment Modes	
	Summary	37
	Automatic axis alignment mode	37
	Grade-matching mode	38
	PlaneLok mode	38
	Using Axis-Alignment and Grade-Reverse Modes	39
	How axis-alignment mode works	39
	Important things to know	39
	Applications	40
	Using Grade-Matching Mode	45
	How grade-matching mode works	45
	Important things to know	45
	Application	46

Using PlaneLok Mode	49
How PlaneLok mode works	49
Important things to know	49
Applications	50
Using the Radio Remote Control to Correct Grade/Height Differences	
After Setup	52
Two-way radio remote control	52
6 Specifications	
Laser	53
Two-way Radio Remote Control.	55
7 Maintenance and Care	
Introduction	57
Storage	57
Battery Disposal	57
System Cleaning	57
8 Troubleshooting	
Introduction	59
Laser	60
Receiver	61
Radio Remote Control	62
Messages	63
Radio remote control messages.	63
Laser error messages	67
9 Calibration	
Introduction	69
Checking Calibration	70
Adjusting the Calibration at the Laser	72
Adjusting the Calibration Using the Radio Remote Control.	74
10 Request for Service and Parts	
Trimble Service Centers	77
Checklist	78

Introduction

Thank you for choosing one of the Spectra Precision™ Lasers from the Trimble® family of precision grade lasers. You've just made a wise investment in field-proven products made by Trimble, the world's largest manufacturer of laser-based leveling, alignment, and grade-control systems.

The grade laser is an easy-to-use tool that allows you to take accurate horizontal measurements with grade up to 750 m (2500 ft) away using a receiver. The exclusive automatic alignment features allow for quick and easy setup. The exclusive temperature and grade compensation systems are designed for superior accuracy so that your grade laser can be used for machine-control, general construction, and surveying applications requiring tight tolerances under all environmental conditions.

Included in this manual is information about setting up, using, maintaining, and troubleshooting the laser system. Use the manual now to learn basic skills, and use it later for reference. For the best performance of your laser system, follow the maintenance and care recommendations in this manual. Be sure to keep this manual in a convenient place for easy referencing.

Your comments and suggestions are welcome; please call the Trimble Construction Division listed below for your local, authorized Trimble office.

Trimble Construction Division
5475 Kellenburger Road
Dayton, Ohio 45424-1099 U.S.A.
(800) 538-7800 (Toll free in U.S.A.)
+1-937-245-5600 Phone
+1-937-233-9004 Fax
www.trimble.com

Claim for Damage in Shipment

The grade laser system generally includes a laser, remote control, receiver, general-purpose clamp, operator's manual, laser safety kit, carrying case, rechargeable batteries, and battery recharger. The components vary depending on the system that you purchase.

You should inspect your laser system as soon as you receive it. It has been packaged for safe delivery. If it is damaged in any way, immediately file a claim with the carrier or, if insured separately, with the insurance company.

Owner's Record

Be sure to record the serial number of each component in the space provided below. Refer to these numbers if you need to contact your Trimble dealer regarding any of these products.

Model # _____

Serial # _____

Features and Functions

Laser

-
- 1 Power button (Ⓞ) – turns the laser on/off.
-
- 2 Status LED – shows the status of various conditions including an internal, electronic, or a mechanical error (solid red), low-battery (flashing yellow), manual mode (flashing red), HI alert (fast flashing red), and out-of-level (flashing green).
-
- 3 Manual button (Ⓢ) – changes the laser from automatic self-leveling to manual mode.
-
- 4 ↙ Axis Up (⬆) and Down (⬇) buttons – change the grade for the ↙ axis.
-
- 5 Rotation-Control button (Ⓢ) – changes the laser beam’s rotation speed (300, 600, and 900 rpm).
-
- 6 ↗ Axis Up (⬆) and Down (⬇) buttons (dual-grade laser only) – change the grade for the ↗ axis.
-
- 7 Axis-Alignment buttons – rotates the grade axis clockwise (Ⓢ) or counterclockwise (Ⓢ). Rotating the grade axis simulates turning the laser on its tripod, with fine adjustment capability.
-
- 8 Liquid Crystal Displays (LCDs) – show the percentage of grade, approximate charge of the batteries, beam’s rotation speed, and axis alignment (if other than zero). The single-grade laser has one LCD.
-
- A photograph of a white and grey laser transmitter. The device has a handle on the right side and a control panel on the front. Eight numbered callouts point to specific features: 1 points to the power button, 2 to the status LED, 3 to the manual button, 4 to the left axis up/down buttons, 5 to the rotation control button, 6 to the right axis up/down buttons, 7 to the axis alignment buttons, and 8 to the LCD display.

2 Features and Functions

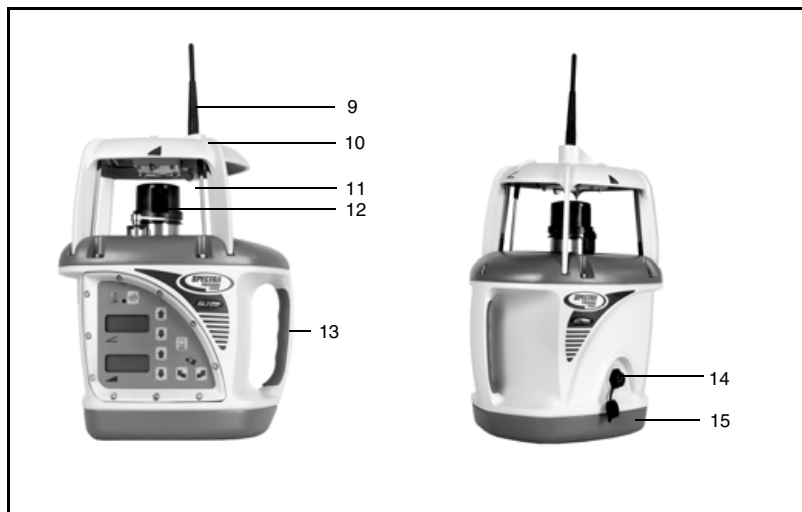

Figure 2.1 Laser transmitter – front and back

-
- | | |
|---|---|
| 9 | Antenna (for radio remote-control lasers only) – sends and receives signals to and from the remote control. |
|---|---|
-
- | | |
|----|--|
| 10 | Sunshade – protects the lighthouse from the environment. |
|----|--|
-
- | | |
|----|--|
| 11 | Lighthouse – is the 360° exit window for the laser beam. The lighthouse is sealed and protects the internal components from the environment. |
|----|--|
-
- | | |
|----|---|
| 12 | Rotor – contains the rotating laser beam. |
|----|---|
-
- | | |
|----|--|
| 13 | Handle – allows you to carry the laser easily. |
|----|--|
-
- | | |
|----|--|
| 14 | Battery Recharging Receptacle – is the 4-pin receptacle that the battery recharger plugs into. It is also used for external power. |
|----|--|
-
- | | |
|----|--|
| 15 | Battery Housing – holds six D-cell Ni-Cd, Ni-MH, or backup alkaline batteries. |
|----|--|
-

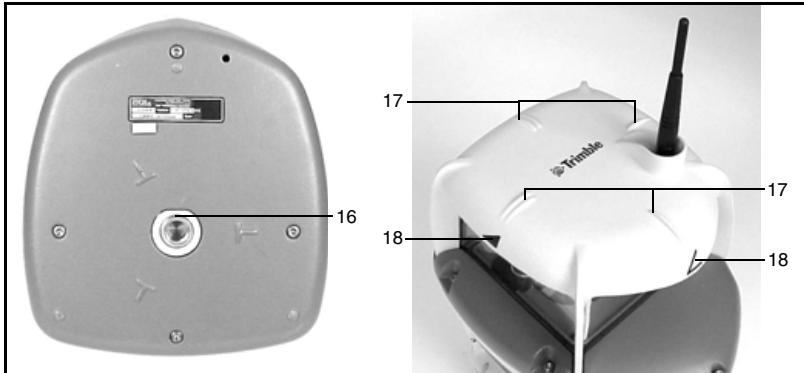

Figure 2.2 Laser transmitter – base and top

-
- 16 5/8-11 Tripod Mount – allows the laser to be connected to a standard 5/8-11 tripod or column mount.
-
- 17 Sighting Guides – are used to visually align the laser with a directional hub or grade stake.
-
- 18 Axis-Alignment Marks – correspond with both laser axes and are used to align the laser in the correct grade direction.
-

Two-Way Radio Remote Control

(Radio equipped lasers only)

- 1 Power/Standby button (Ⓜ) – turns the remote control on/off and activates/deactivates standby mode.
- 2 Manual button (Ⓜ) – changes the laser from automatic self-leveling to manual mode.
- 3 Mode button (Ⓜ) – allows you to choose the laser's operational mode, which includes grade change, automatic axis alignment, grade matching, PlaneLok, grade reverse, and beam rotation speed.
- 4 Up (↑) and Down (↓) buttons – increase/decrease the grade for the ↙ and ↘ axes and increase/decrease the laser beam's rotation speed. When the laser is in manual mode, these buttons can also be used to increase/decrease the slope of the laser beam.
- 5 Left (←) and Right (→) buttons – increase/decrease the slope of the ↗ axis when the laser is in manual mode.
- 6 Liquid Crystal Display (LCD) – shows the mode messages, beam's rotation speed, and percentage of grade.
- 7 Enter/Backlight button (Ⓜ) – is a multifunctional button that confirms the selection made from the laser's operational mode and activates the backlighting function.
- 8 Antenna – transfers signals between the radio remote control and laser.
- 9 Remote port contacts – transfer operation and elevation information between the remote control and the receiver.

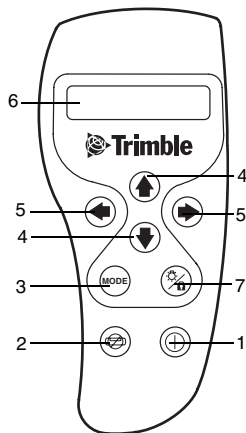

- 10 Mounting clip – allows the remote control to be connected to a grade-rod holster, belt, or a screw on a wall.

- 11 Battery Housing – holds two AA alkaline batteries.

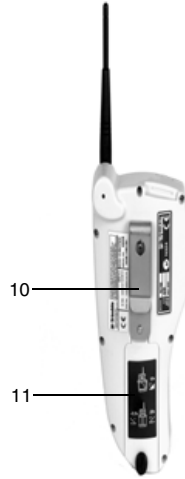

Accessories

Connector cable

1 Mounting guides – fit into the mounting channels on the receiver or the radio remote control.

2 Contacts – transfer grade-display signals between the hand-held receiver and radio remote control.

3 Clamp – connects to the receiver so signals can be transferred between the receiver and the radio remote control.

4 4 m (12-ft) cable – transfers signals between the radio remote control and a hand-held receiver.

5 Clamp – connects to the radio remote control so signals can be transferred between the receiver and the radio remote control.

To install:

1. Put the small key of the clamp into the guide on the back of the radio remote control.
 2. Clip the top part of the clamp into the guide on the front of the radio remote control.
-

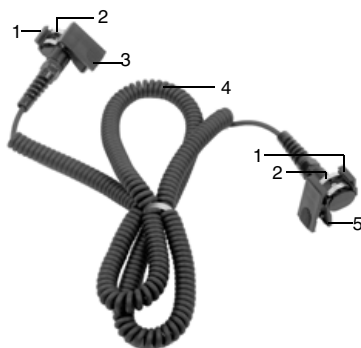

Remote holster

- 1 Mounting slot – provides an opening for the radio remote control clip to be slipped into.
- 2 Mounting strap – allows the radio remote control to be connected to the grade rod for automatic alignment functions. The holes in the strap accommodate grade rods of varying sizes.

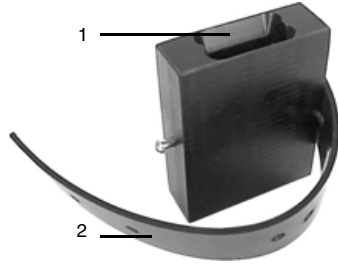

Battery recharger

- 1 4-socket plug with retaining collar – connects to the 4-pin receptacle on the laser.
- 2 Grounded receptacle connects to the supplied grounded electrical power cord.



External power cable

- | | |
|---|--|
| 1 | Alligator clips (+ and -) – connect to the positive (+) and negative (-) terminals on a 12-V DC battery. |
| 2 | 4-socket plug – connects to the 4-pin receptacle on the laser. |

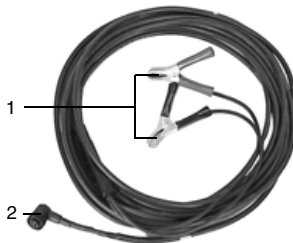

M100 3½-8 Adapter

The 3½-8 adapter allows you to connect the laser which has a 5/8-11 threaded mount to a tripod or other mounting device that has a 3½-8 threaded mount.

M102 Quick-disconnect adapter

The quick-disconnect adapter allows you to quickly disconnect the laser from the tripod.

M103 Steep-grade adapter

The steep-grade adapter allows the internal leveling mechanism of the steep-grade laser to level the laser at grades greater than 25%.

1243 Sighting scope (GL710 and GL720 only)

The sighting scope allows manual alignment of the grade axis to a known reference point. This scope is not required for a radio remote-control laser.

How to Use the Laser System

Powering the Laser – Batteries

Depending on the laser system configuration that you purchase, the laser is shipped with either rechargeable nickel-cadmium (Ni-Cd) or nickel/metal-hydride (Ni-MH) batteries.

Temperature affects battery-charging time. For the best results, charge the batteries when the ambient temperature is in the range from 10 °C to 40 °C (50 °F to 104 °F). Charging at a higher temperature may damage the batteries. Charging at a lower temperature may increase the charge time and decrease the charge capacity, resulting in loss of performance and shortened battery-life expectancy.

Even if you buy a laser that uses Ni-Cd batteries, you can upgrade to Ni-MH batteries. The upgrade installation, however, must be performed by an authorized service center.

Alkaline batteries can also be used as a backup; however, rechargeable batteries should be reinstalled in the laser as soon as possible.

To let you know when the batteries are getting low, the status LED flashes. When the status LED flashes yellow, the laser has less than one hour of running time. When the status LED remains on solid yellow, the batteries have less than five minutes running time.

After shipment, the batteries may not have enough power to operate the system. Be sure to recharge the batteries before use. The intelligent recharger maximizes battery life and reduces the time before battery replacement by precisely controlling the recharging/discharging cycle and by not overcharging the batteries. The maximum time to achieve a full charge is six hours.

Recharging the batteries

Note – Do not recharge alkaline batteries. Trying to recharge them does not damage the laser but the batteries do not recharge.

1. Plug the 4-socket plug into the laser and tighten the retaining collar.
2. Plug the supplied grounded electrical power cord into the battery-recharger.
3. Plug the grounded electrical power cord into an appropriate outlet.

Note – The recharging status is indicated on the recharger.



Left LED	Right LED	Recharging Status
Off	Off	No connection or no batteries
Off	On	Recharging is in progress
Flashing	Off	Recharging is complete
Flashing	Flashing	Recharging error

Note – The laser will not operate while the batteries are recharging.

Note – Some countries or local areas have regulations regarding the disposal of rechargeable batteries. Please be sure to follow the regulation in your area.

Installing/removing the batteries



Warning – The Ni-CD and Ni-MH batteries may contain small amounts of harmful substances.

- Be sure to charge the battery before using it for the first time, and after not using it for an extended length of time.
- Charge only with specified chargers, according to device manufacturer's instructions.
- Do not open the battery, dispose of it in a fire, or short circuit it. These actions may cause the battery to ignite, explode, leak, or get hot, causing personal injury.
- Dispose in accordance with all applicable federal, state, and local regulations.
- Keep the battery away from children. If swallowed, do not induce vomiting. Seek medical attention immediately.

1. Remove the four screws from the battery housing. Remove the battery-housing compartment.
2. Install/remove the batteries.

Note – When installing the batteries, be sure to note the positive (+) and negative (-) diagram inside of the housing.

Note – The laser has reverse polarity protection. If the batteries are put in wrong, no damage occurs to the laser but it does not work. Allow it one minute to recover after the batteries have been installed correctly.

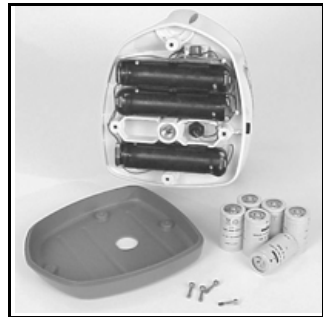

3. Put the battery-housing compartment in place and reinstall the four screws.

Powering the Laser – External Cable

The laser system also includes an external power cable so you can operate the laser in case the internal batteries become discharged. The internal batteries will not recharge, however, while you're using the external power cable.

Connecting/disconnecting the external power cable



Caution – To avoid damaging the laser, make sure the laser is off before connecting or disconnecting the external power cable to/from the laser.

1. Connect the alligator clips to a 12-V DC automotive or motorcycle battery noting the correct polarity (red = positive, black = negative).
2. Plug the 4-socket plug into the laser and tighten the retaining collar.
3. To disconnect the external power cable from the laser, loosen the retaining collar, unplug the 4-socket plug from the laser, and remove the alligator clips from the battery.



Learning the Basic Laser Functions

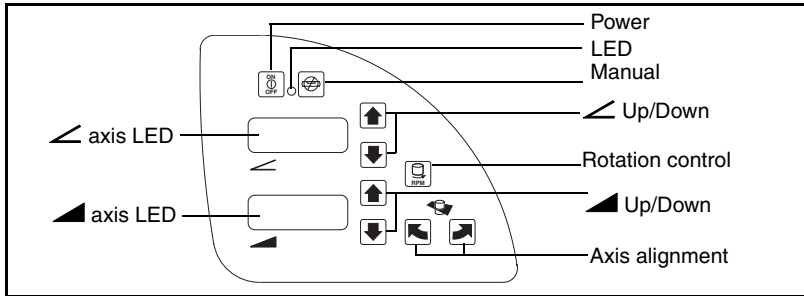

Figure 3.3 Laser control buttons

Turning on/off the laser

1. Press the power button (⏻) to turn on the laser.

Note – The laser always powers up in the automatic self-leveling mode. If the laser is out of its self-leveling range and remains out of it for more than 10 minutes, the laser shuts down completely.

Note – When the laser is initially turned on, the LCD shows the approximate charge of the batteries, the laser beam's rotation speed, and manual axis-alignment position if it's other than zero. After the LCD shows this information, the last-entered grade immediately appears in the LCD. The status LED flashes green to indicate that the laser is self-leveling. After the laser has self-leveled at the indicated grade, the laser beam rotates and the status LED stops flashing.

Note – After the laser has been level for more than 15 minutes, the HI alert activates. If the laser is disturbed (tripod bumped, etc.) so that when it re-levels the laser beam elevation changes by more than 1/8 in. (3.0 mm), the HI alert shuts down the laser and rotor, and the status LED flashes red two times per second (twice the manual-mode rate).

2. To turn off the laser, press and hold the power button for three seconds.

Selecting the rotation speed

The laser has three laser beam rotation speeds—300, 600, and 900 rpm. The rotation speed can be changed at any time to meet your job-site conditions. Use 600 rpm for held-held receivers and most machine-control systems.

- Repeatedly press and release the rotation-control button (⏏) until the desired rotation speed appears in the LCD.

Note – The selected rotation speed briefly appears in the LCD. After a few seconds, the selected percentage of grade appears in the LCD.

Changing the grade value

The grade value for both axes can be changed using two methods—standard and quick-change. The standard method is used for entering small changes in the grade value. The quick-change method is used for setting grade to zero and entering large changes in the grade value.

Standard method

- Press and hold the up or down button for the axis you want to change until the correct grade value appears in the laser's LCD.

Note – The speed of the grade value change increases with the amount of time the button is held down.

Note – Grade values from -0.500 to 9.999% are displayed in thousandths of a percent. Grade values greater than 10% are displayed in hundredths of a percent.

Note – On all models, all changes to the axis-alignment rotation made before you change the grade value using the standard method are retained.



Quick-change method

Note – The grade value can be quickly set to 0.000% by simultaneously pressing and holding the up and down buttons for the axis you want to change.

1. Simultaneously press and hold the up and down buttons for the axis you want to change to set the grade value to 0.000%.

Note – The grade value for the ▲ axis increases in 1.00% increments. The grade value for the ∟ axis increases in 5.00% increments.

2. Continue pressing and holding the up and down buttons until the correct grade value appears in the laser's LCD.

Note – When the grade value for either axis reaches its highest amount, the grade value switches to the lowest value for that axis. In the  axis, for example, the value switches from +10.00% to -10.00%. In the  axis, the value switches from 25.00% to -0.500%. For steep-grade lasers, the value switches from 110.00% to -0.500%.

Note – On models 722 and 742 only, all changes to the axis-alignment rotation made before you change the grade value using the quick-change method are cancelled.

Activating/deactivating manual mode

Manual mode bypasses the laser's automatic self-leveling mode so you can use the laser in vertical mode. Manual mode also allows you to tilt the laser beyond its built-in sloping capability so you can perform steep-sloping horizontal applications.

1. Make sure the laser is on and in the orientation appropriate for your application needs (horizontal or vertical).
2. Press the manual mode button (.

Note – When manual mode is activated, the status LED flashes red once per second and scrolling horizontal segments appear in the LCD.

3. To resume automatic self-leveling mode, press the manual mode button again.

Rotating the axis alignment manually

The axes-alignment buttons () allow you to electronically rotate the laser so that the grade of the laser beam properly aligns to the job-site grade.

1. To make coarse adjustments, look through the sighting guides on top of the laser and turn the laser on the tripod until it is properly aligned.
2. To make fine adjustments, press and hold the axis-alignment button that corresponds to the direction you want to rotate the laser's axis until the desired rotation has been reached.

Note – A vertical line in the LCD moves to the left or right to give you a rough indication of the rotation position.

Two-Way Radio Remote Control

(Radio equipped lasers only)

Installing/removing the radio remote control batteries



Warning – The Ni-CD and Ni-MH batteries may contain small amounts of harmful substances.

- Be sure to charge the battery before using it for the first time, and after not using it for an extended length of time.
 - Charge only with specified chargers, according to device manufacturer's instructions.
 - Do not open the battery, dispose of it in a fire, or short circuit it. These actions may cause the battery to ignite, explode, leak, or get hot, causing personal injury.
 - Dispose in accordance with all applicable federal, state, and local regulations.
 - Keep the battery away from children. If swallowed, do not induce vomiting. Seek medical attention immediately.
-

1. Turn the battery-housing knob counterclockwise to release the battery-housing door.
2. Install/remove the batteries.

Note – When installing the batteries, be sure to note the positive (+) and negative (-) diagram inside of the housing.

Note – The radio remote control has reverse-polarity protection. If the batteries are put in wrong, no damage occurs to the radio remote control but it does not work. Allow it one minute to recover after the batteries have been installed correctly.

3. Put the battery-housing door in place and turn the battery-housing knob clockwise.

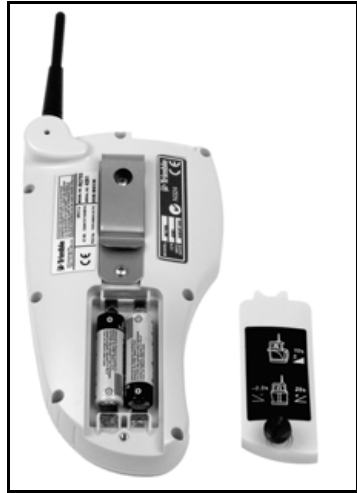

Learning basic radio remote control functions

The radio remote control is a hand-held device that allows you to send operational commands to the laser from a remote location. While using the radio remote control, make sure its antenna is pointing skyward. For example, if you're holding the radio remote control in your hand and using it in the horizontal orientation, the antenna should be at a 90° angle to the radio remote control.



If you connect the radio remote control to a grade rod, and the radio remote control is oriented vertically, the antenna should point upward from the top of the radio remote control.

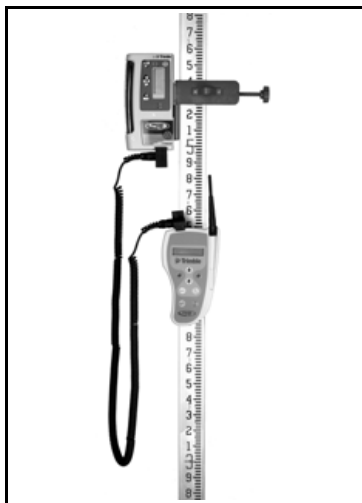

Turning on/off the radio remote control

1. Press the power button (Ⓜ) to turn on the radio remote control.

Note – When the radio remote control is initially turned on, the axes symbols and last-entered grade for each axis appear in the LCD.

2. To turn off the radio remote control, press and hold the power button for 3 seconds.

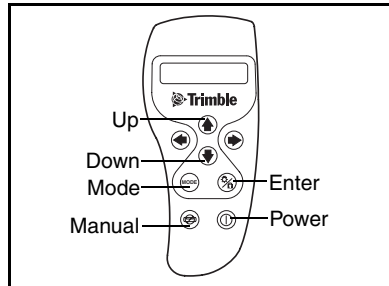

Selecting the operational mode

The mode button allows you to choose the laser’s operational mode, which includes automatic axis alignment, grade matching, PlaneLok, grade reverse, and beam rotation speed. A “hidden” button sequence also allows you to calibrate the laser from the radio remote control (see the “Calibration” section of this manual for more information).

1. Repeatedly press and release the mode button to cycle through the operational mode menu. The menu selections appear in the radio remote control’s LCD.

Confirming the operational mode

1. Press the mode button (Ⓜ) to select the operational mode appropriate for your application needs.
2. Press the enter button (Ⓜ) to confirm your selection.

Activating/deactivating the backlighting feature

- Press and hold the enter button to activate backlighting. Backlighting turns off automatically to save battery life.

Selecting the rotation speed

The laser has three laser beam rotation speeds—300, 600, and 900 rpm. The rotation speed can be changed at any time to meet your job-site conditions. Use 600 rpm for held-held receivers and most machine-control systems.

1. Select “Rotation Speed” from the operational mode menu using the mode button (⊕).
2. Repeatedly press and release the radio remote control’s up (↑) or down (↓) button until the desired rotation speed has been selected.

Note – The rotation speed appears in the two-way radio remote control’s LCD.

Changing the grade value

The grade value for both axes can be changed using two methods—standard and quick-change. The standard method is used for entering small changes in the grade value. The quick-change method is used for setting grade to zero and entering large changes in the grade value. The grade value flashes 1 time per second while the laser is leveling to the new grade value. Once level, the grade display stops flashing.

Standard method

Note – The last-entered grade value for each axis appears in the radio remote control’s LCD.





1. Select the desired grade axis (↙ or ↘) from the operational mode menu using the mode button (⊕).
2. Press and hold the up (↑) and down (↓) button for the axis you want to change until the desired grade value appears in the laser’s LCD.



Note – The speed of the grade value change increases with the amount of time the button is held down.

Note – Grade values on the radio remote control are displayed in thousandths of a percent.



Note – On all models, all changes to the axis-alignment rotation made before you change the grade value using the standard method are retained.

Quick-change method

1. Select the desired grade axis ( or ) from the operational mode menu using the mode button (.
2. Simultaneously press and hold the up () and down () buttons for the axis you want to change to set the grade value to 0.000%.

Note – The grade value for the  axis increases in 1.00% increments. The grade value for the  axis increases in 5.00% increments.

3. Continue pressing and holding the up and down buttons until the desired grade value appears in the laser's LCD.

Note – When the grade value for either axis reaches its highest amount, the grade values switches to the lowest value for that axis. In the  axis, for example, the value switches from +10.00% to -10.00%. In the  axis, the value switches from 25.00% to -0.500%. For steep-grade lasers the value switches from 110.0% to -0.500%.

Note – On models 722 and 742 only, all changes to the axis-alignment rotation made before you change the grade value using the quick-change method are cancelled.

Activating/deactivating manual mode

Manual mode bypasses the laser's automatic self-leveling mode so you can use the laser in vertical mode. Manual mode also allows you to tilt the laser beyond its built-in sloping capability so you can perform steep-sloping horizontal applications.

1. Press the manual mode button (☹).

Note – When manual mode is activated, the laser's status LED flashes red once per second and scrolling horizontal segments appear in the laser's LCDs.

2. Use the up (⬆) and down (⬇) or left (⬅) and right (➡) buttons to electronically change the slope or line of the laser beam. As you press the up and down or left and right buttons, the symbol for the grade axis you are changing appears in the LCD (↙ or ↘).
3. To resume automatic self-leveling mode, press the manual mode button again.

Activating automatic-axis-alignment, grade-matching, and PlaneLok modes

Note – For more detailed information about these modes, please see the System Setup section of this manual.

1. Select the desired mode from the operational mode menu using the mode button (☹).
2. Select the axis (↙ or ↘) that you are aligning using the radio remote control's up (⬆) or down (⬇) buttons.
3. Press the enter button (Ⓜ) to confirm the selection.
4. While the system is aligning, "Start" followed by "Wait" appears in the radio remote control's LCD.
5. When the alignment has been completed, "Complete" appears in the radio remote control's LCD.

Note – Alignment can take one to five minutes to complete.

Activating/deactivating standby mode

Standby mode, which can only be activated by using a two-way radio remote control, is a power-saving feature that conserves laser battery life.

1. Quickly press and release the radio remote control's power button (Ⓢ) to activate standby mode.

Note – When standby mode is activated, the laser beam, rotor, self-leveling system, and LEDs shut down while the HI-alert function still checks the laser setup. So that you know that the laser is in standby mode rather than being turned off, dashed lines appear in the laser's LCD. In the radio remote control's LCD, the word "standby" appears.

2. To deactivate standby mode and restore full operation of the laser, quickly press and release the radio remote control's power button again. The laser and all other functions turn on again.

General Setup Information

- Prior to beginning work, decide where to place the laser for optimum coverage of the job site.
- Place the laser on the job site where it will be out of the way of traffic and will not be obstructed by equipment with respect to the machine-mounted receiver.
- Set the height of the tripod and laser so that the laser beam will strike the receiver when it's positioned correctly on a machine or grade rod.
- Adjust the laser's alignment to the job site as needed.
- When using the radio remote control, make sure the radio remote control's antenna is pointing skyward and the laser's antenna is flipped up. An "R" appears in the right corner of the remote's first display line indicating a connection to the receiver has been made and the power is on.
- When the radio remote control and laser are "linked," a flashing bar above the "T" (antenna icon) appears in the right corner of the radio remote control's LCD.
- The laser-beam operating radius for the standard laser models is 460 m (1,500 ft).
- The radio-remote-control operating radius for the standard operating modes is 230 m (750 ft). The operating radius for the radio remote control in automatic alignment modes is 150 m (500 ft).

Getting Connected

Laser

Connecting the laser to a tripod

All lasers have a 5/8-11 tripod mount on the bottom of the laser so you can connect the laser to a standard tripod, column clamp, or other mounting device. The laser can also be used without a tripod, but the laser must be set on a stable surface.

In addition to using the laser in horizontal mode, you can use it in vertical mode. To do so, however, an after-market vertical mounting bracket is needed. For instruction on how to use the vertical mounting bracket, consult the specific manufacturer's instructions.

1. Insert the tripod's 5/8-11 screw into the laser's threaded 5/8-11 tripod mount.
2. Turn the screw counterclockwise to hold the laser securely in place.
3. To detach the laser from the tripod, turn the screw clockwise.



Connecting the laser to the adapters

Depending on the laser system you purchase, additional mounting accessories may be shipped with your laser. The steep-grade laser system includes a steep-grade adapter.

M100 3 1/2-8 and M102 Quick-disconnect adapters

- Thread the appropriate adapter into the 5/8-11 threaded mount on the bottom of the laser.

Note – The carrying case is designed so the adapter can remain on the laser.

M103 Steep-grade adapter

1. Set up a tripod so that its mounting surface is as close to true level as possible. Make sure that one of the tripod legs is aligned to the down-grade side of the  axis of the laser.
2. Make sure that the steep-grade adapter is connected to the laser at the mark that indicates the required grade range.
3. Connect the steep-grade adapter to the tripod.

Radio remote control

Connecting the remote holster to a grade rod

- Wrap the mounting strap around the grade rod and fasten it securely in place.

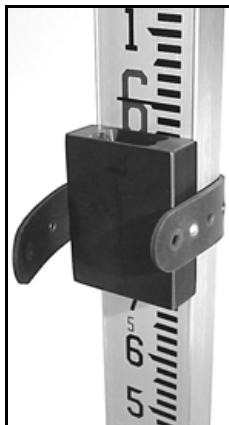

Connecting the radio remote control to the remote holster

- Slip the radio remote control mounting clip into the mounting slot of the remote holster.



Setting Up the Laser System

Setting up the laser in manual mode

- 1. Press the manual mode button (⊕) on the laser or radio remote control.

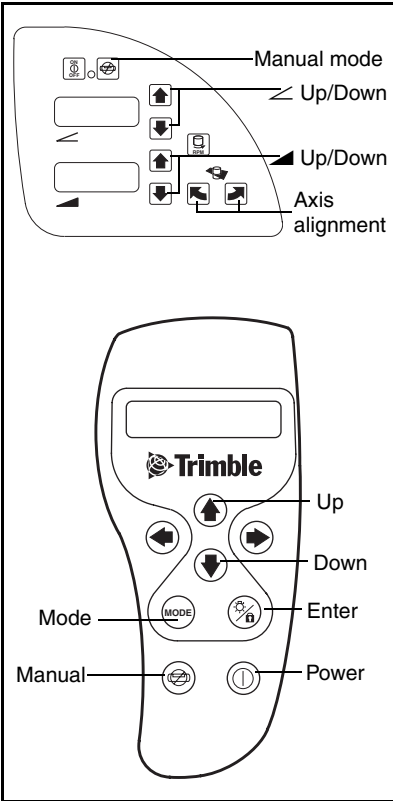

Note – When manual mode is activated, the laser’s status LED flashes red at a 1-Hz rate and scrolling horizontal segments appear in the laser’s LCDs. If you are using a two-way radio remote control, “Manual Mode” also appears in the radio remote control’s LCD.

- 2. To adjust the laser in the ↙ axis so that the laser beam matches the desired grade, use the up (↑) and down (↓) buttons on the laser or radio remote control.
- 3. To adjust the laser in the ↗ axis so that the laser beam matches the desired grade, use the up and down buttons on the laser or the left (←) and right (→) buttons on the radio remote control.
- 4. To resume automatic self-leveling mode, press the manual button on the laser or radio remote control again.



Aligning the axis manually

The manual axis alignment buttons (↻ ↺) are primarily used on lasers that don't have radio remote control capability. These buttons rotate the grade axis electronically (simulates turning the laser on its tripod, with fine adjustment capability up to a maximum of ± 40 degrees).

1. Set up the laser over a reference point. Make sure the laser is positioned so that the  axis and  axis are pointing in the right direction.
2. Using the sighting guides as a guide, rotate the laser on its tripod to align the laser to the direction hub.
3. Turn on the laser and allow it to self-level. Set the grade value on both axes to zero.
4. Connect a receiver to a grade rod and turn on the receiver.
5. Set the grade rod on the direction hub and adjust the receiver until you get an on-grade reading.

Note – If only one person is manually aligning the laser, use a bipod (commonly used with prism poles) to keep the grade rod plumb when placing it on the direction hub.

6. Change the grade value on the cross axis, for example, to 4%. Press the appropriate manual axis alignment button to align the laser plane to the receiver. The clockwise axis alignment button (↻) rotates the laser clockwise; the counterclockwise axis alignment button (↺) rotates the laser counterclockwise.
7. Press and hold the axis alignment button until you get an on-grade reading on the receiver again. Then dial the grade value appropriate to your application on one or both axes.

Setting up the laser in vertical mode

1. Set up the laser on its side.

Note – If you're using the laser with a tripod, an after-market vertical mounting bracket is needed. For instruction on how to use the vertical mounting bracket, consult the specific manufacturer's instructions.

2. Press the manual button (⊕) on the laser or radio remote control.
3. To adjust the laser beam for line direction, use the \angle axis up (⬆) and down (⬇) buttons on the laser or radio remote control until the laser beam matches the line point.
4. To adjust the plumb position of the laser beam, use the up and down buttons on the laser or the left (⊖) and right (⊕) buttons on the radio remote control.

Establishing Control

Determining height of instrument (HI)

1. Set up the laser and turn it on.
2. Connect a receiver to a grade rod. Turn on the receiver.
3. Place the grade rod on a job-site benchmark (BM). Adjust the height of the receiver until the receiver's LCD shows an on-grade reading.
4. Add the grade-rod reading to the height of benchmark to determine the height of instrument. Use the HI as a reference for all other elevation measurements.

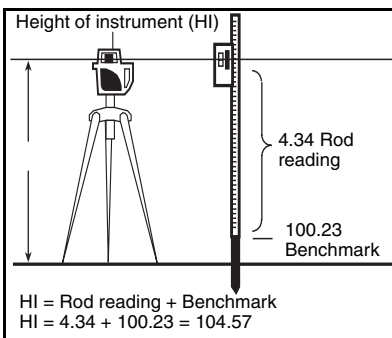

Establishing elevation-control hubs

The elevation-control hub can be used to re-establish the elevation of the laser plane in case the laser setup gets disturbed.

- Establish an elevation-control hub close to the laser and determine the HI.

Note – If you're also going to establish grade-control hubs, make sure the elevation-control hub and one of the grade-control hubs are on the same axis.

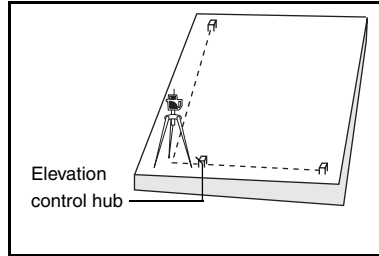

Establishing grade-control hubs

The grade-control hub can be used to check the alignment of the laser on the job site and to confirm the grade entered into the laser.

- Check the grade on a minimum of three hubs on the job site. The hubs should be in lines that are 90° from one another with one line containing two hubs.

Note – Because the accuracy of this procedure is based on the known elevation of the hubs, the exact elevation of the hubs is critical.

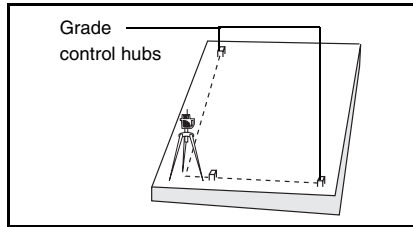

Note – If there isn't enough space for the laser to be setup on the desired centerline, the laser can be set up on a line parallel to the centerline ($D1=D2$).

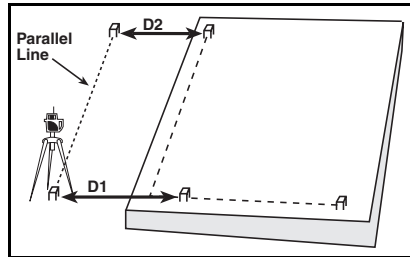

Reversing the Grade

(Two-way radio remote control)

The sign of the \blacktriangle axis can be changed using the two-way radio remote control.

1. Set up the laser. Turn on the laser and flip its antenna up.
2. Turn on the radio remote control and make sure its antenna is pointing skyward.
3. Select “ \blacktriangle Reverse” from the menu using the mode button (Ⓜ).
4. Press the enter button (Ⓢ) to confirm the selection.

Note – On a two-way radio remote control, the sign of the \blacktriangle grade value reverses to indicate that \blacktriangle reversing has been completed.

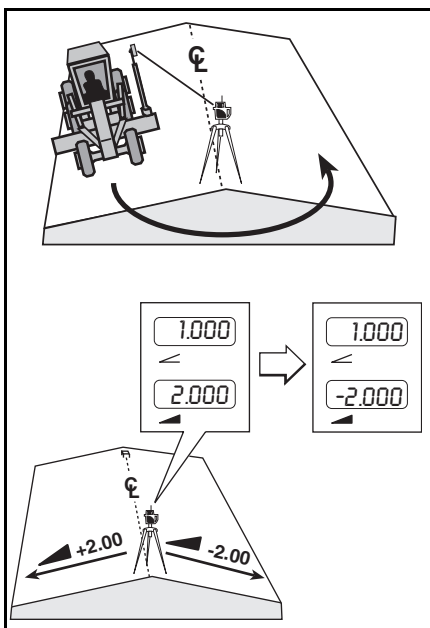

Automatic Alignment Modes

Summary

The laser system has three automatic alignment modes:

- Axis Alignment
- Grade Matching
- PlaneLok

To use these modes, a radio remote control and hand-held receiver are required. The radio remote control and receiver are typically mounted to a grade rod, which must be placed somewhere between 20 m (60 ft) and 150 m (500 ft) from the laser. Automatic axis alignment can take from 1 – 5 minutes to complete.

Automatic axis alignment mode

This automatic axis alignment function replaces the manual alignment scope and vernier base traditionally used to align the desired grade axis to a hub.

When this mode is being used, the receiver and radio remote control are mounted to a grade rod, the desired grade is dialed into the laser, and the grade rod is placed on the hub that the grade axis is being aligned to. When activated, automatic axis alignment mode adjusts the direction the desired grade axis is pointing to by electronically simulating “rotating” the laser on its mounting base. This mode is typically used for agriculture, road construction, and steep-grade applications where precision alignment of the grade axis is required.

Grade-matching mode

This automatic alignment function changes the grade of the desired axis to automatically match an unknown grade.

When this mode is being used, the receiver and radio remote control are mounted to a grade rod, the approximate grade (within 1.5° of the actual grade) is dialed into the laser, and the grade rod is benchmarked to the laser-beam elevation at a point within 1 m (3 ft) of the laser. Without changing the receiver's elevation on the rod, the grade rod is then placed anywhere a grade reading is needed.

When activated, grade-matching mode automatically adjusts the grade up or down to “search” for the receiver. When the center of the receiver is found, the resultant grade is calculated and dialed into the laser, and displayed on the two-way radio remote control.

When grade matching is complete, the receiver can be removed from the alignment point and the calculated grade will remain in the laser. Both axes of the laser can be grade matched in sequence. Grade-matching mode is used for applications where the existing grade is not known, but will remain relatively unchanged (such as installation of a sidewalk or driveway).

PlaneLok mode

PlaneLok mode works like grade-matching mode, except the receiver is permanently mounted to the desired elevation so that the laser can use the receiver to continually monitor beam elevation. The laser ignores the internal level vial for that axis, using the absolute elevation from the receiver for level control.

PlaneLok Mode is used for applications where extreme precision of the laser-beam elevation is required, such as runway applications.

Using Axis-Alignment and Grade-Reverse Modes

How axis-alignment mode works

Axis-alignment mode works by changing grade in the aligned-axis direction and cross-axis directions then monitoring the elevation changes of the laser beam at the receiver via the radio remote control. The desired axis-alignment angle can then be calculated and the internal grade system “rotated” electronically to align the simulated grade axis to the desired point.

Important things to know

Automatic Axis Alignment:

- Replaces the alignment scope and vernier base traditionally used
- Can be done from any side of any axis of the laser, even if grade is dialed into the opposite axis that’s being aligned
- Automatically adjusts the direction the grade axis is pointing to the receiver/remote location
- Electronically simulates rotating the laser on its base to match the hub

For Proper Operation:

- The desired grades must be entered into the laser
- The receiver must be at the correct alignment point
- The receiver must be between 20 m (60 ft) and 150 m (500 ft) from the laser

For Best Accuracy:

- The laser beam must strike the receiver’s photocell. You do not need to adjust the receiver to an on-grade reading.
- Set up the laser to align to the elevation reference the farthest away (such as the centerline of the road)
- If the hubs are equally distant, align to the hub with the smallest amount of grade

Applications

Road construction

The main uses for the laser in road construction are for planar sections where the road design calls for no vertical or super-elevated curves.

Automatic axis alignment mode

1. Set up the laser over a point on the centerline of the road.
2. Using the sighting guide as a guide, rough align the laser with the direction hub on the centerline.

Note – Because the laser can provide positive and negative grades in the \blacktriangle axis, make sure the laser's handle is at a 90° angle to the centerline of the road.

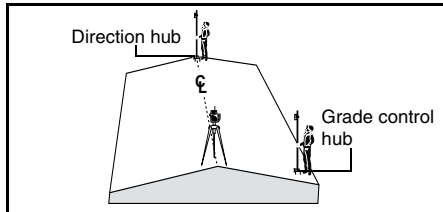

Note – If there isn't enough space for the laser setup on the centerline, the laser can be set up on a line parallel to the centerline of the road ($D1$ and $D2$ are the same distance).

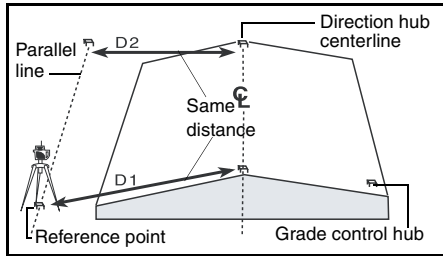

3. Enter the grade value for the axis that aligns with the centerline of the road (\blacktriangle).

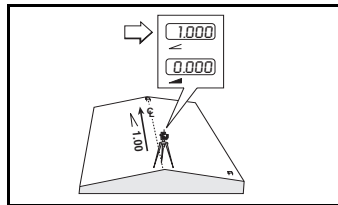

4. Enter the grade value for the side of the road to be graded first into the axis that is perpendicular to the centerline of the road (▲).
5. Connect a receiver and radio remote control to a grade rod.
6. Set the grade rod on the centerline direction hub.
7. Slide the receiver up/down the grade rod until the laser beam strikes the receiver's photocell.
8. Select "Axis Align" from the operational menu using the radio remote control's mode button (Ⓜ).
9. Select the axis (◀ or ▶) that you are aligning using the up (↑) or down (↓) buttons.
10. Press the enter button (Ⓜ) to confirm the selection. "Start" then "Wait" appears on the LCD.
11. Hold the grade rod plumb and steady during automatic axis alignment.

Note – Alignment can take from 1 to 5 minutes to complete.

Note – When axis alignment has been completed, "Axis Align Complete" appears in the LCD. If axis alignment fails, a failure message appears in the LCD.
12. Check the laser's alignment and grade values using previously established elevation-control hubs and grade-control hubs as references.

Note – If the alignment and grade values need small adjustments, they can be changed using the radio remote control. See the "Correcting Grade/Height Differences" section of this manual for more information.
13. Grade that side of the road.

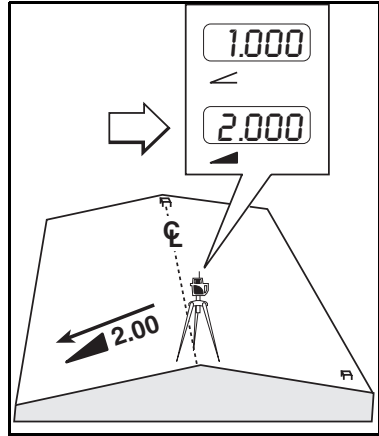

5 Automatic Alignment Modes

Grade reverse mode

Note – After you’ve finished grading one side of the road, you can reverse the sign of the ▲ axis from the cab using the radio remote control.

1. Set the blade on a known elevation hub on the centerline of the road.
2. Select “▲ Reverse” from the operational menu using the radio remote’s mode button (⊖).
3. Press the enter button (Ⓢ) to confirm the selection.

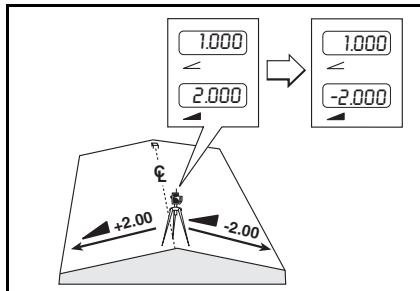
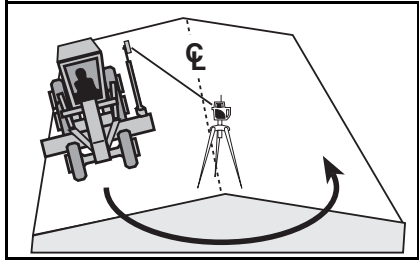

Step grade (embankments, waste dumps, and sea walls)

1. Set up a tripod on an established offset from the baseline of the bank to make sure that the laser beam will be at the required height above the bank surface. Make sure that one of the tripod legs is aligned with the down-grade side of the \angle axis.

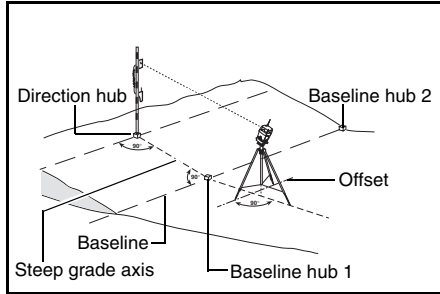

2. Connect the steep-grade adapter to the tripod.
3. Make sure that the steep-grade adapter points to the laser with the mark that indicates the required grade range.

4. Align the adapter with the direction hub on the top of the bank.
5. Connect the laser to the steep-grade adapter making sure that the laser's handle is parallel with the baseline of the bank.



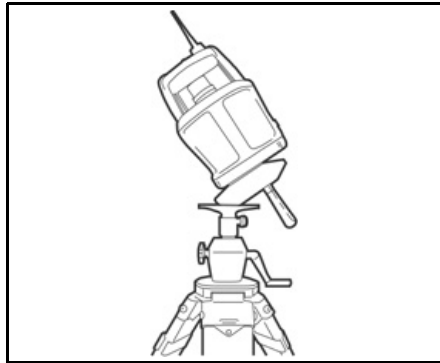

6. Make sure the desired grade and rotation speed are entered into the laser.
7. Using the sighting guides as a guide, rough align the laser with the direction hub.



8. Connect a receiver and radio remote control to a grade rod.
9. Set the grade rod on the direction hub.
10. Slide the receiver up/down the grade rod until the laser beam strikes the receiver's photocell.

*Note – The grade rod **must** be plumb.*

11. Select “Axis Align” from the operational menu using the radio remote control's mode button (⊕).

12. Select the axis ( or ) that you are aligning using the up () or down () buttons.
13. Press the enter button () to confirm the selection. “Start” then “Wait” appears on the LCD.
14. Hold the grade rod plumb and steady on the direction hub.

Note – Alignment can take 1 to 5 minutes to complete.

Note – When axis alignment has been completed, “Axis Align Complete” appears in the LCD. If axis alignment fails, a failure message appears in the LCD. (See the “Troubleshooting” section of this manual for more information.)

15. Check the laser’s alignment using previously established direction hub and baseline hubs as references.

Note – If the alignment and grade values need small adjustments, they can be changed using the radio remote control. See the “Correcting Grade/Height Differences” section of this manual for more information.

Note – If the axis alignment should be done to the baseline hub #2 (perpendicular to the steep grade axis), make sure that the tripod mount is aligned with the reference point at the baseline. Follow the steps as described above with the only change that the axis alignment using the grade rod has to be done at baseline hub #2 (steps 7, 9, and 14) instead of the direction hub.

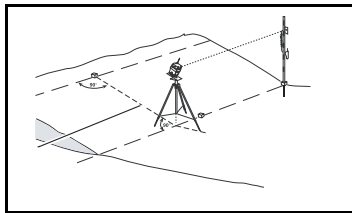

Using Grade-Matching Mode

How grade-matching mode works

Grade-matching mode works by changing grade in the selected axis direction then monitoring the elevation changes of the laser beam at the receiver via the radio remote control. Once the laser “finds” the center of the receiver, the resultant grade is calculated and stored in the laser and two-way remote control.

Important things to know

Grade-Matching Mode:

- Automatically adjusts the grade of the selected axis to match an unknown grade
- Searches for and finds “on-grade” of the mounted receiver within a 1.5° grade range of the final grade (starting with the beam centered on the receiver isn’t necessary)
- Stores and displays the resultant grade on the remote and laser

For Proper Operation:

- The receiver can be removed after alignment, and the resultant grade remains in the laser
- One or both axes can be grade matched in sequence
- The initial grade **must** be within 1.5° of the final grade before starting

Application



General construction

One axis

If the  axis is not at 0% grade, the laser has to be aligned in automatic axis alignment mode with grade-control hub #2 before the grade-matching mode can be activated.

1. Set up the laser over the reference point.
2. Using the sighting guide as a guide, rough align the laser with grade-control hub #2.



Note – The laser and control hub #1 must be on one axis, which is at 0% grade.

3. Enter the approximate grade value for the  axis and 0% for the  axis.

Note – The automatic grade-searching range is $\pm 1.5^\circ$. The approximated grade should be within 1.5° of the final matched grade.

4. Connect a hand-held receiver and radio remote control to a grade rod.
5. Set the grade rod on control hub #1.
6. Slide the receiver up/down the grade rod until the receiver's LCD shows an on-grade reading.

*Note – The grade rod **must** be plumb.*

7. Go to grade-control hub #2 and set the grade rod on the hub. Make sure you **do not** change the height of the receiver on the grade rod.
8. Select “Grade Match” from the operational menu using the mode button (⊖).
9. Select the axis ( or ) that you are aligning using the up (↑) or down (↓) buttons.
10. Press the enter button (Ⓜ) to confirm the selection. “Start” then “Wait” appears in the radio remote control LCD.

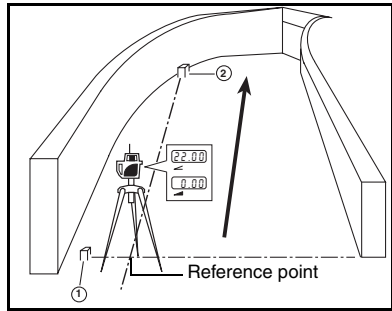

- Hold the grade rod plumb and steady on grade-control hub #2 during grade matching.

Note – “Grade Match Complete” appears in the radio remote control’s LCD when grade matching has been completed. If grade matching fails, a failure message appears in the radio remote control LCD. (See the “Troubleshooting” section of this manual for more information.)

Note – The resultant grade appears in the laser’s LCD display and on the two-way remote control’s LCD display.

Note – Alignment can take 1 to 5 minutes to complete.



Two axes

This function can only be done on one axis at a time. The laser needs to be aligned with one of the grade-control hubs in automatic axis alignment mode before dual axes grade-matching mode can be activated.

- Set up the laser over a reference point.
- Using the sighting guide as a guide, rough align the laser with the grade-control hub #1.

Note – The two grade-control hubs must be in lines that are at a 90° angle from one another.

Note – The laser, elevation-control hub, and grade-control hub #2 must be on one axis.

- Enter the approximate grade value for the  axis and the  axis.

Note – The automatic grade searching range is $\pm 1.5^\circ$. The approximated grade should be within 1.5° of the final matched grade.

- Connect a hand-held receiver and radio remote control to a grade rod.
- Set the grade rod on the elevation-control hub.
- Slide the receiver up/down the grade rod until the receiver’s LCD shows an on-grade reading.

Note – The grade rod **must** be plumb.

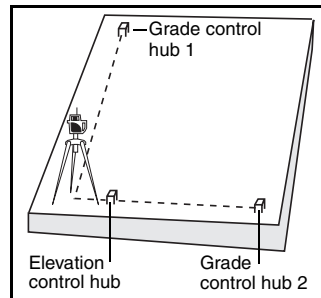

7. Go to grade-control hub #1 and set the grade rod on the hub. Make sure you **do not** change the height of the receiver on the grade rod.
8. Select “Grade Match” from the operational menu using the mode button (Ⓜ).
9. Select the axis (↙ or ↘) that you are aligning using the up (⬆) or down (⬇) buttons.
10. Press the enter button (Ⓜ) to confirm the selection. “Start” then “Wait” appear in the LCD.

11. Hold the grade rod plumb and steady on grade-control hub #1 during grade matching.

Note – “Grade Match Complete” appears in the radio remote control’s LCD when grade matching has been completed. If grade matching fails, a failure message appears in the radio remote control’s LCD. For more information, see Troubleshooting, page 59.

Note – The matched grade value for the aligned axis appears in the laser’s and two-way radio remote control’s LCDs.

Note – Alignment can take 1 to 5 minutes to complete.

12. Go to grade-control hub #2 and set the grade rod on the hub. Make sure you **do not** change the height of the receiver on the grade rod.
13. Select “Grade Match” from the operational menu using the mode button (Ⓜ).
14. Select the axis (↙ or ↘) that you are aligning using the up (⬆) or down (⬇) buttons.
15. Press the enter button (Ⓜ) to confirm the selection.
16. Hold the grade rod plumb and steady on grade-control hub #2 during grade matching.

Note – “Grade Match Complete” appears in the radio remote control’s LCD when grade matching has been completed. If grade matching fails, a failure message appears in the radio remote control’s LCD. For more information, see Troubleshooting, page 59.

Note – The matched grade value for the aligned axis appears in the laser’s and two-way radio remote control’s LCDs.

Note – Alignment can take 1 to 5 minutes to complete.

Using PlaneLok Mode

How PlaneLok mode works

PlaneLok mode works by changing grade in the selected axis direction then monitoring the elevation changes of the laser beam at the receiver via the radio remote control. Once the laser “finds” the center of the receiver, it continues to monitor its position and makes small corrections to hold the beam on-grade.

Important things to know

- Loss of receiver signal results in laser “out-of-level” mode (no laser beam and rotation)
- The internal laser level vial for that axis is ignored (the receiver is used for level control)
- The opposite axis levels to its internal level vial and grade

PlaneLok

- Works like grade match mode, except the receiver is permanently mounted at the desired elevation to continually monitor beam elevation
- Is used for applications requiring extreme accuracy, such as in runway applications

For proper operation:

- The initial grade *must* be within 1.5° of the final grade before starting

Applications

Agricultural and runways

Agriculture and runway applications can generally be handled using any of the previously described processes. For extremely accurate agriculture or runway applications whose work-time extends over several days or even weeks, PlaneLok mode is recommended.

PlaneLok mode

1. Set up the laser over a reference point.
2. Using the sighting guide as a guide, rough align the laser with one of the grade-control hubs.

Note – The two grade-control hubs must be in lines that are at a 90° angle from one another.

3. Enter the approximate grade into the axis that needs to be aligned and an exact grade value into the other axis.

Note – The automatic grade searching range is $\pm 1.5^\circ$. The approximated grade should be within 1.5° of the final matched grade.

4. Connect a receiver and radio remote control to a grade rod.
 5. Set the grade rod on the elevation-control hub.
 6. Slide the receiver up/down the grade rod until the receiver's LCD shows an on-grade reading.
- Note – The grade rod **must** be plumb.*
7. Go to the grade-control hub on the axis to be aligned and set the grade rod on the hub. Make sure you **do not** change the height of the receiver on the grade rod.
 8. Select “PlaneLok” from the operational menu using the mode button (⊞).
 9. Select the axis (↙ or ↗) that you are aligning using the up (↑) or down (↓) buttons.

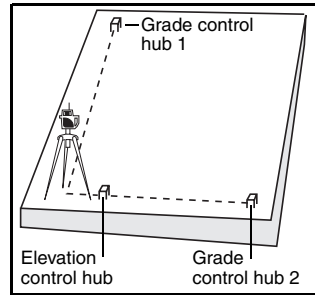

10. Press the enter button (Ⓜ) to confirm the selection. “Start” then “Wait” appears in the LCD.

Note – When the PlaneLok function has been completed, “PlaneLok Complete” and a “Lock” icon (padlock symbol) appear in the radio remote control’s LCD.

Note – Alignment can take 1 to 5 minutes to complete.

Note – If the PlaneLok function fails, the remote indicates the cause of failure. See the “Troubleshooting” section of this manual for more information.

Note – The receiver should be permanently mounted at this location and at the desired elevation. Use a tripod (commonly used with prism poles) to hold the grade rod steady for the entire workday.

Note – The resultant grade on the locked axis is displayed in the remote control’s LCD.

Note – The laser continues to servo to the receiver’s elevation signals. Any loss of signal over an extended period of time (1 minute) causes the laser beam to turn off and rotor to stop. The PlaneLok mode must be reactivated when the laser experiences loss of signal over an extended period.

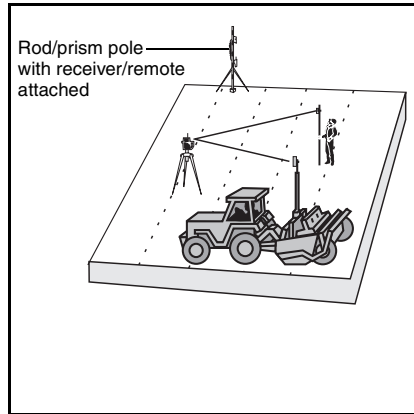

11. To exit the PlaneLok function, select “PlaneLok” again using the mode button. Then press the enter button.

Note – As a confirmation, “Exiting” appears in the radio remote control’s LCD.

Using the Radio Remote Control to Correct Grade/Height Differences After Setup

Sometimes, after performing any of the advanced alignment functions, the alignment and grade values need small adjustments. These adjustments can be made using a two-way radio remote control.

Two-way radio remote control

Checking grade/height differences for the \angle and \blacktriangle axes

1. Determine the height of the laser (HI) by setting the grade rod on elevation-control hub #1.
2. Check the HI by setting the grade rod on elevation-control hub #2. Make sure you **do not** change the height of the receiver on the grade rod.

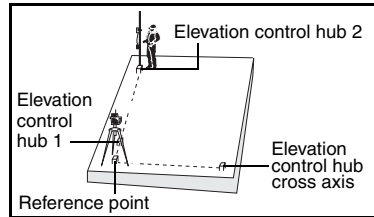

Adjusting grade/height differences on the \angle axis

1. Select “ \angle Grade” from the operational mode menu using the radio remote control’s mode button (⊖).
2. Press the up (⬆) or down (⬇) button on the radio remote control until you get an on-grade reading on the receiver.

Note – The new grade value appears on the radio remote control’s LCD.

Adjusting grade/height differences on the \blacktriangle axis

1. Go to the elevation-control hub for the \blacktriangle axis and set the grade rod on the hub. Make sure you **do not** change the height of the receiver on the grade rod.
2. Select “ \blacktriangle Grade” from the operational mode menu using the radio remote control’s mode button (⊖).
3. Press the up (⬆) or down (⬇) button on the radio remote control until you get an on-grade reading on the receiver.

Note – The new grade value appears on the two-way radio remote control’s LCD.

Specifications

Laser

Accuracy	Single, Dual, and Steep-Grade Models: Servo Deadband Accuracy: 4.6 arc seconds Grade Resolution: 0.001% Diameter: accurate for machine-control and agricultural applications to 900 m (3,000 ft)	
Laser Type/Classification	658 nm IEC Class 2 (Standard models) 785 nm IEC Class 1 (IR Models)	
Laser Power Output	Single-, Dual-, and Steep-Grade Models: 3.5 mW IR Models: Less than 1 mW	
Operating Temperature	-20 °C to 50 °C (-4 °F to 122 °F)	
Storage Temperature	-40 °C to 60 °C (-40 °F to 140 °F)	
Operating Range (Radius)	Standard and Steep-Grade Models: 460 m (1,500 ft)	
Grade Range (Single-Grade Models)	▲ axis	N/A
	∠ axis	-0.500% to 25%
Grade Range (Dual-Grade Models)	▲ axis	-10% to 10%
	∠ axis	-0.500% to 25%
Grade Range (Steep-Grade Model)	▲-axis	-10% to 10%
	∠ axis	-0.500% to 110%
Rotation Speeds	300, 600, 900 rpm	
Self-Leveling Range	The laser will self level up to 25% grade	
Power Source	6.0 Ah Ni-Cd 8.5 Ah Ni-MH	

6 Specifications

Battery Life (Radio Models)	20 Hours (Ni-Cd) 30 Hours (Ni-MH) 20 Hours (Alkaline, emergency use only)
Recharging Time	6 hours, maximum
Low Battery Operations	1 hour with Ni-Cd batteries
Automatic Shutoff	30 minutes if unable to level
Tripod Screw	5/8-11 standard 3½-8 and quick-disconnect (optional)
Water Resistance	Completely sealed and waterproof
Weight	8.4 Kg (18.5 lb)
Size	30 x 25 x 20 cm (H x W x D) 11.75 x 10.0 x 7.75 in.(H x W x D)

Two-way Radio Remote Control

Size	13 x 8 x 4 cm (H x W x D) 5 x 3 x 1.5 in. (H x W x D)
Weight	0.5 Kg (1 lb)
Operating Temperature	-20 °C to 50 °C (-4 °F to 122 °F)
Storage Temperature	-40 °C to 60 °C (-40 °F to 140 °F)
Frequency	2.4 GHz digital
Operating Range (Standard Functions)	Line of sight up to 230 m (750 ft)
Operating Range (Automatic Alignment Functions)	Line of sight up to 150 m (500 ft)
Angular Coverage	360°
User Interface	8 buttons and an LCD
Power Source	2 x AA alkaline
Battery Life	100 hours of typical system (laser with remote) operation at room temperature. Battery life can be greatly reduced in cold temperature or if an unusual amount of automatic alignment functions are performed.

Maintenance and Care

Introduction

You will get years of service from the leveling system by following the maintenance and care recommendations in this manual. Carry the laser in its moisture-resistant, field-tested carrying case to safely move the laser from one job to another.

However well the product is designed, mishaps do occur. The most common problems associated with these are covered in the following areas.

Storage



Caution – Do not store the laser in a wet carrying case. If the case gets wet, open it and let it dry before storing the laser.

Battery Disposal

Some countries, states, and local areas have regulations regarding the disposal of rechargeable batteries. Be sure that replaced batteries are disposed of properly.

System Cleaning

Use only a good-quality glass cleaner and a soft cloth to clean all external optical components. A dry cloth used on the laser's/radio remote control's optical components or displays could scratch or damage these surfaces.

Blow off any loose debris before cleaning any surfaces to prevent scratching of optical surfaces. Monthly, wipe off with a moist, clean cloth any dust or dirt from the laser's outer surface and inside the battery housing. Clean all corroded battery contacts with a pencil eraser or baking soda solution.

Troubleshooting

CHAPTER

8

Introduction

If none of the following techniques corrects the problem, take your system to a local Trimble dealer or authorized service center for evaluation or repair.

Laser

Problem	Solution
Laser will not turn on	<ul style="list-style-type: none">• Make sure the batteries have sufficient power and are installed correctly.• Make sure the batteries contacts are in proper working condition.
No signal is received at the receiver	<ul style="list-style-type: none">• Make sure the receiver is turned on.• Make sure the batteries have sufficient power and are installed correctly.• Make sure the laser is sending out a beam.• Check for a laser signal with another receiver.
No laser beam	<ul style="list-style-type: none">• Make sure the laser is on.• Make sure the batteries have sufficient power and are installed correctly.• Make sure that the laser (standard model) is within its self-leveling range (up to 25%).• Switch the laser into manual mode; the laser should come on.
The battery life is short	<ul style="list-style-type: none">• Make sure high-quality batteries are being used.• When recharging the batteries, make sure the charger is plugged into an appropriate ac outlet. The batteries require a minimum charge time of six hours.
Radio remote control is not working with the laser	<ul style="list-style-type: none">• Make sure the antenna is upright.• If the remote does not work with the laser, the remote needs to be “matched” to the laser for proper operation. Return the laser to an authorized service center for the matching procedure to be performed.
Laser beam not accurate	<ul style="list-style-type: none">• Check and adjust calibration as needed.• Return the laser to an authorized service center for inspection.

Receiver

Problem	Solution
Receiver does not receive a laser signal	<ul style="list-style-type: none"> • Make sure the laser receiver is on. • Make sure the batteries have sufficient power and are installed correctly. • Make sure the batteries contacts are in proper working condition. • Make sure the receiver is within the operating range of the laser. • Try receiving the laser beam with another receiver.
Receiver occasionally beeps when it is not in the laser beam	<ul style="list-style-type: none"> • Make sure the receiver is not near radar or high-frequency radio stations. • Make sure the laser beam is not bouncing off a highly reflective surface.



Radio Remote Control

Problem	Solution
Radio remote control not receiving	<ul style="list-style-type: none">• Clear the failure message by quickly pressing and releasing the power button (Ⓜ) to place the laser in standby mode. When the laser is in standby mode, quickly press and release the power button again to return to normal operating mode with the failure message cleared.• Make sure the radio remote control is on.• Make sure the batteries contacts are in proper working condition.• Make sure you have a good connection between the receiver and radio remote control.• Make sure the radio remote control antenna is mounted solidly on the radio remote control.
Radio remote control is damaged (may include loose or broken LCD)	<ul style="list-style-type: none">• Return the damaged radio remote control as described in the “Request for Service and Parts” section.

Messages

Radio remote control messages

Operating Messages	Meaning
Start/Wait	Automatic alignment is started and in process
Standby	The laser is on and in standby mode
↙ Grade	Grade value for ↙ axis can be changed
▲ Grade	Grade value for ▲ axis can be changed
Axis Align	Automatic axis alignment can be selected
PlaneLok	PlaneLok mode can be selected
Grade Match	Grade match mode can be selected
▲ Reverse	Grade reverse for the ▲ axis can be selected
RPM	Rotor speed can be changed
Operating Messages	Meaning
Axis Align Complete	Completion of automatic axis alignment
Grade Match Complete	Completion of automatic grade matching
PlaneLok Complete	Completion of automatic PlaneLok
300, 600, 900	Shows the selected rotation speed

Failure Messages	Meaning	Possible Solution
No Receiver	Searched for receiver but couldn't find it	<ul style="list-style-type: none"> • Move the grade to within 1.5° of the range needed for the receiver to pick up the beam • Make sure the receiver is not blocked from the laser beam • Make sure your laser setup is stable • Receiver disconnected from the remote control.
Lost Receiver	Searched and found a receiver but lost it while processing the function	<ul style="list-style-type: none"> • Make sure the beam path to the receiver is not blocked after any functions on the remote are activated • Make sure your laser setup is stable • Check the remote for low battery power • Poor electrical contact between receiver and remote control
Angle Limit	Axis alignment computes a rake angle greater than 40°	<ul style="list-style-type: none"> • Repeat the laser setup and make sure the alignment is correctly set
Mechanical Limit	The beam could not scan across the entire receiver	<ul style="list-style-type: none"> • Position the receiver so that it is within the grade limits of ±10% on the  axis and +25% to -0.5% on the  axis
Wind Disturbance	Windy conditions have made detection of the beam impossible	<ul style="list-style-type: none"> • Make sure the beam path to the receiver is not blocked after any functions on the remote are activated • Make sure your laser setup is stable

Failure Messages	Meaning	Possible Solution
Time Out	A step or stage could not complete its alignment function within the allotted time	<ul style="list-style-type: none"> • Setup the laser so that it is within leveling range • Make sure your laser setup is stable by stabilizing the tripod • Make sure the beam path to the receiver is not blocked after any functions on the remote are activated
Too Close	The receiver is too close to the laser	<ul style="list-style-type: none"> • Move the receiver more than 20 m (60 ft) from the laser • Remove any reflective objects from the path of the beam
Too Far	The receiver is too far from the laser	<ul style="list-style-type: none"> • Operate the receiver within 150 m (500 ft) from the laser • Position the receiver to be within the beam operating range
Failure	Unidentified error	
Fail Auto FN	Automatic alignment feature was not able to complete	<ul style="list-style-type: none"> • Replace low batteries in the remote or laser • Move the receiver within the automatic alignment range of 20 m to 150 m (60 ft to 500 ft)
Remote Battery	Remote batteries are discharged	<ul style="list-style-type: none"> • Replace the batteries
Laser Battery	Laser batteries are discharged	<ul style="list-style-type: none"> • Charge the batteries, install backup Alkaline batteries, operate off external power
Error at Laser	Internal laser malfunction	<ul style="list-style-type: none"> • Contact the closest service center

Failure Messages	Meaning	Possible Solution
HI Alert	The laser setup has moved and the beam may be at the wrong elevation	<ul style="list-style-type: none"> • Check the setup • Clear the HI warning by turning Off/On the laser transmitter, or by putting the remote control in “Standby” then out of “Standby”
Grade Limit	During an automatic alignment function, the laser was unable to complete the alignment due to insufficient grade range	<ul style="list-style-type: none"> • Align the laser closer to the direction hub • Tilt the tripod to allow more grade range • Reduce the grade
Bad Receiver Cable	Poor electrical connection	<ul style="list-style-type: none"> • Check/clean/reattach the cable between the remote control and the receiver
Lost Radio Link	Radio is out of range or there is interference	<ul style="list-style-type: none"> • Move the radio remote control closer to the laser • Move to an area with less radio interference, such as away from power lines or radio transmitting towers
Calibration Mode Not Ready	When calibrating with the Remote Control, you pressed the enter button (Ⓜ) before the radio established contact with the laser	<ul style="list-style-type: none"> • On remote control power up once the calibration grades have been entered, wait a few seconds for the radio link to be established before pressing the enter button
Calibration Mode Non-Zero Rake	A rake angle is currently stored in the laser	<ul style="list-style-type: none"> • Press both axis rotation buttons (Ⓜ Ⓜ) to zero the rake angle

Note – Clear the failure message by quickly pressing and releasing the remote control's button (Ⓢ) to place the laser in standby mode. When the laser is in standby mode, quickly press and release the power button again to return to normal operating mode with the failure message cleared.

Note – An axis symbol and the grade appear in the top of the LCD. If the axis has been locked in PlaneLok mode, a lock symbol appears after the grade value.

Laser error messages

The laser has error codes that indicate either a hardware or software problem. If one of the following codes appears in the laser's LCD, please return the laser to an authorized Trimble service center:

- 0004 • 0008 • 0010 • 0020 • 0040 • 0080 • 0100
- 0200 • 0400 • 0800 • 1000 • 2000 • 4000 • 8000

For more information about returning the laser to a service center, please see the "Request for Service and Parts" section of this manual.

Introduction

As with any precision instrument, the calibration needs checking on a regular basis (such as the beginning of each job, or if the laser has been handled roughly). If the laser is to be used below freezing, be sure to check calibration under those conditions.

The laser has a calibration error when the laser plane coming out one side of the laser is above true level, and the laser plane coming out the opposite side is below true level. Adjusting the position of the laser plane requires making minor adjustments the leveling mechanism using the up (▲) and down (▼) buttons on the control panel.

When the laser is properly calibrated, it emits a 360° horizontal level plane so that if the laser is turned 180° or 90° from its original position, the reading is within ± 8 mm per 90 m ($\pm 5/16$ in per 300 ft) of the original position.

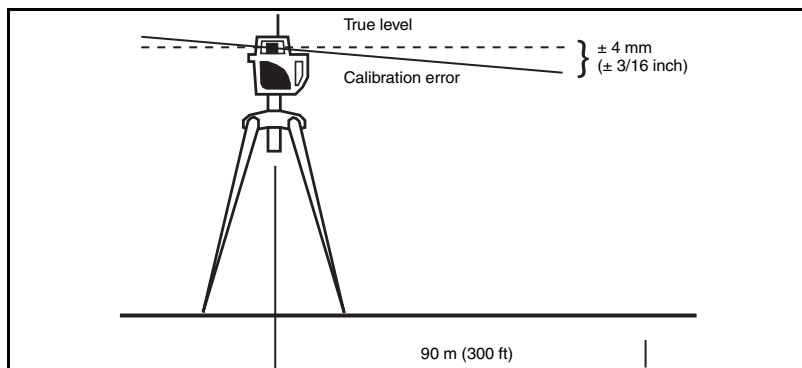

To check the horizontal calibration, you'll need a tripod with a 5/8-11 threaded mount and a hand-held receiver. If you need to adjust the calibration, having another person to help saves time.

Checking Calibration

1. Set up the laser 90 m (300 ft) from a wall.

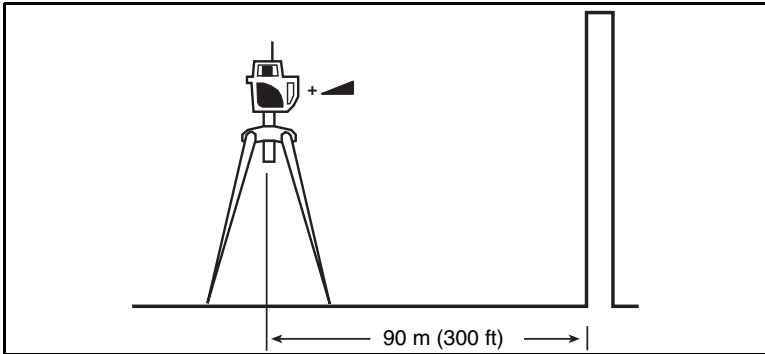

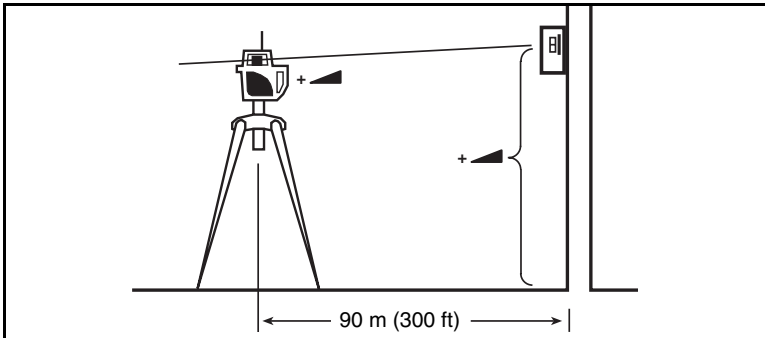

2. Set the grade to 0.000% in both axes.
3. Raise/lower the receiver until you get an on-grade reading for the + axis. Using the on-grade marking notch as a reference, make a mark on the wall.

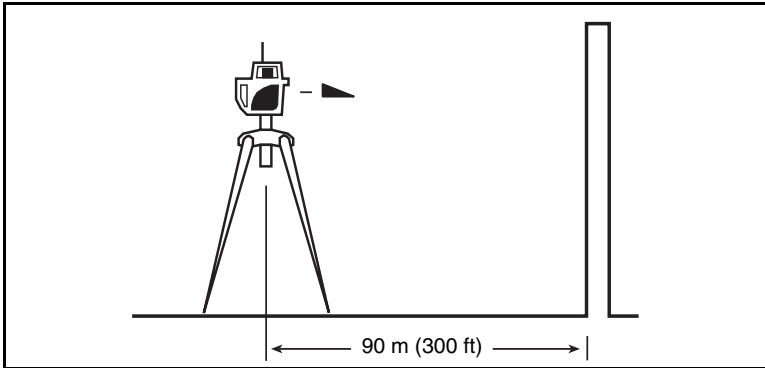

Note – For increased precision, use the fine-sensitivity setting (1/16 in / 1.5 mm) on the receiver.

4. Rotate the laser 180° (– axis toward the wall) and allow the laser to re-level.



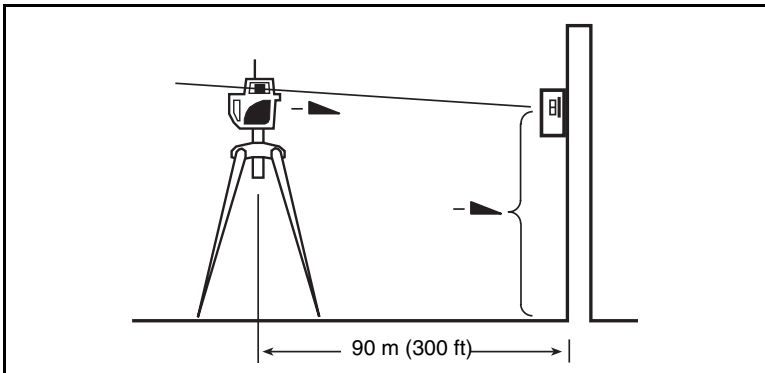

5. Raise/lower the receiver until you get an on-grade reading for the $-$  axis. Using the on-grade marking notch as a reference, make a mark on the wall.







6. Measure the difference between the two marks. If they differ more than $5/16$ in. (8 mm), the laser needs calibrating.

Adjusting the Calibration at the Laser

Before you calibrate the laser, press both axes rotation buttons to clear any stored rake angle.

1. Position the receiver at the midpoint of the two marks on the wall.
2. Add/subtract grade in the appropriate axis using the up() / down() buttons. The grade appears in the LCD.

Note – The up/down buttons needed to calibrate the  axis on single grade lasers are “hidden” behind the control panel.

3. When the beam is centered in the receiver, use the following “hidden” button sequence to store the new calibration value and to zero out the grade display:
 - a. Press and hold the manual button () .
 - b. Quickly press and release the power button () (do **not** press the power button long enough to turn off the laser)
 - c. Press and release the up button for the  axis
 - d. Release the manual button
 - e. The grade display will zero out to indicate calibration is complete
4. Rotate the laser 180° back to the original face. Make sure this axis is less than 5/16 in. (8 mm) from the midpoint line.

Note – If additional adjustment is required, repeat steps 1–3 above.

5. After adjusting the \blacktriangleleft axis, rotate the laser 90°. Repeat the above starting with the + \triangleleft axis facing the wall.

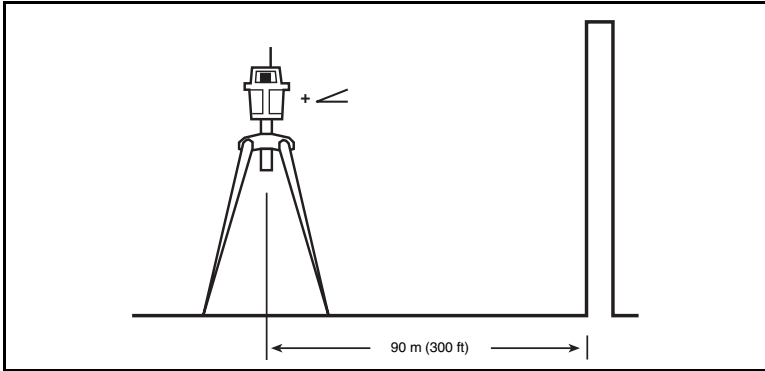

Adjusting the Calibration Using the Radio Remote Control

Before you calibrate the laser, press both axes rotation buttons to clear any stored rake angle.

1. Position the receiver at the midpoint of the two marks on the wall.
2. Add/subtract grade in the appropriate axis using the grade increase/decrease modes on the radio remote control (Grade Change).
3. When the beam is centered on the receiver's LCD, use the following "hidden" button sequence to store the new calibration point and to zero out the grade display:
 - a. Turn off the radio remote control
 - b. Press and hold the manual button (Ⓜ)
 - c. Turn on the radio remote control. "Calibration" appears in the LCD
 - d. Press the enter button (Ⓜ) to confirm the selection
 - e. The grade display on the laser and two-way radio remote control will zero out to indicate calibration is complete
4. Rotate the laser 180° back to the original face. Make sure this axis is less than 8 mm (5/16 in) from the midpoint line.

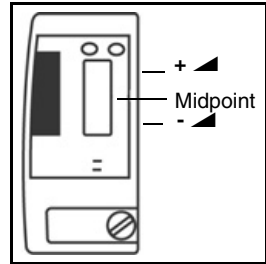

Note – If additional adjustment is required, repeat Step 1 through Step 3 above.

5. After adjusting the \blacktriangleleft axis, rotate the laser 90° . Repeat Step 1 through Step 4 above, starting with the $+\triangleleft$ axis facing the wall.

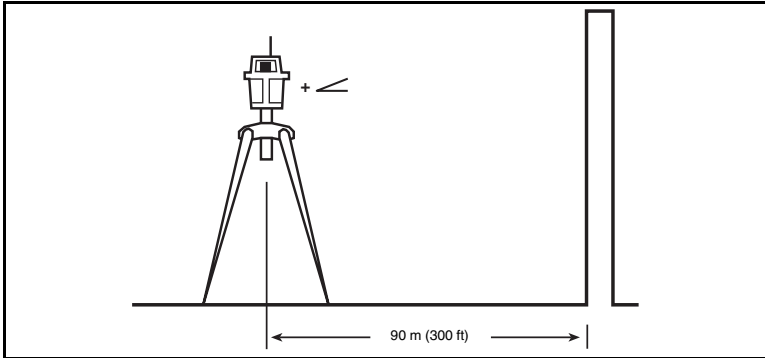

Request for Service and Parts

Our goal is to provide prompt and efficient service through competent service dealers. To locate your local dealer or authorized Trimble Service Center for service, accessories, or spare parts, contact one of our offices listed below.

Trimble Service Centers

North America

Trimble Construction Division 5475 Kellenburger Road Dayton, Ohio 45424-1099 U.S.A.	(800) 538-7800 (Toll Free in U.S.A.) +1-937-245-5600 Phone +1-937-233-9004 Fax www.trimble.com
--	---

Europe

Trimble GmbH Am Prime Parc 11 65479 Raunheim GERMANY	+49-6142-2100-0 Phone +49-6142-2100-550 Fax
---	--

Asia-Pacific

Trimble Navigation Australia PTY Limited Level 1/120 Wickham Street Fortitude Valley, QLD 4006 AUSTRALIA	+61-7-3216-0044 Phone +61-7-3216-0088 Fax
--	--

Latin America

Trimble Navigation Limited 6505 Blue Lagoon Drive Suite 120 Miami, FL 33126 U.S.A.	+1-305-263-9033 Phone +1-305-263-8975 Fax
--	--

Africa & Middle East

Trimble Export Middle-East	+971-4-881-3005 Phone
P.O. Box 17760	+971-4-881-3007 Fax
Jebel Ali Free Zone, Dubai	
U.A.E.	

China

Trimble Beijing	+86-10-8857-7575 Phone
Room 2602-05, Tengda Plaza,	+86-10-8857-7161 Fax
No.168 Xiwai Street	www.trimble.com.cn
Haidian District	
Beijing, CHINA 100044	

Checklist

Before returning your system for repair, be sure to do the following:

1. Put a note into the package identifying yourself as the owner.
2. Explain the operating difficulty.
3. Include a return address and telephone number.
4. If the equipment is under warranty, provide verification of the date of purchase.
5. Pack the equipment securely for shipment in its original carrying case.
6. Return the equipment prepaid and insured to your local dealer or authorized Trimble Service Center.
7. Request estimate of charges for non-warranty or other service work before repair begins. If estimates are not requested, repair work will begin immediately.

All certified outlets have factory-trained personnel and use authorized replacement parts to ensure proper and quick return. For long-distance shipments, UPS, 2nd-Day Air, or airfreight is recommended.

Except for one-way transportation charges, there will be no charge for repairs caused by problems due to defective materials and/or workmanship under warranty.



Trimble Construction Division
5475 Kellenburger Road
Dayton, Ohio 45424-1099
USA
+1-937-245-5600 Phone

Contractors-Tools.com



1-877-866-5721

www.trimble.com



© 2002–2007, Trimble Navigation Limited. All rights reserved.
Reorder PN 1445-0100 Rev. C (09/07)